

WINTER 2026  
*Collection*





## HEAD OFFICE & WORKSHOP

Blachere Illumination S.A.S  
22 Allée des Bourguignons, 84400, Apt  
Tel : + 33 (0) 413 068 002

Mail : [sales@blachere-illumination.com](mailto:sales@blachere-illumination.com)  
Web : [blachere-illumination.com](http://blachere-illumination.com)

## CONTACTS

Géraldine - tél : +33 (0) 490 747 323  
[geraldine@blachere-illumination.com](mailto:geraldine@blachere-illumination.com)  
Léa - tél : +33 (0) 490 747 642  
[Lalves@blachere-illumination.com](mailto:Lalves@blachere-illumination.com)  
Marion - tél : +33 (0) 490 747 330  
[marion@blachere-illumination.com](mailto:marion@blachere-illumination.com)  
Sandrine - tél : +33 (0) 490 747 396  
[s.cerda@blachere-illumination.com](mailto:s.cerda@blachere-illumination.com)  
Marie - tél : +33 (0) 490 747 044  
[marie@blachere-illumination.com](mailto:marie@blachere-illumination.com)  
Cathy - tél : +33 (0) 490 747 325  
[cathy@blachere-illumination.com](mailto:cathy@blachere-illumination.com)

## PHOTOGRAPHERS

- Camille Moirenc
- Peter Mason
- Irene Yrstad
- Eddy Olsen
- Sara Verdejo P.

Print • Groupe Prenant

## ALL RIGHTS RESERVED

Not a contract document. The sizes and wattages of motifs may be subject to change for technical reasons.  
Non-contractual images.

All our products are CE marked meaning that they meet electrical security norms and electromagnetic requirements. All our motifs, designs and graphics are protected by the INPI, the OMPI and current industrial and intellectual property laws.

Reproduction of any kind, in full or part, is strictly forbidden without written authorisation of blachere illumination s.a.s.

Get inspired at [blachere-illumination.com](http://blachere-illumination.com)



# SUMMARY

## *catalogue*

1  
2  
3  
4  
5

**VOLUMES**  
*& urbain*

14 - 77

**SUSPENSIONS**  
*collections*

78 - 163

**STRING LIGHTS**  
*& luminous curtains*











164 - 246

**DECORATIONS**

247 - 270

**ACCESSORIES**  
*& technical solutions*

271 - 293

-  Height
-  Length
-  Width
-  Voltage
-  Weight
-  Flash colour
-  LED colour
-  Print colour
-  News
-  Recycled bottles

## our HISTORY

**It all began in Apt, in the heart of Provence, in 1973. When Jean-Paul Blachère illuminated his first village, the smiles on the residents' faces were his confirmation that light has a unique magical power.**

He then turned this experience into a profession, a passion and know-how that he passes on with love and respect for tradition.

We have now grown, delivering our decorations in over 80 countries, supported by our 600 members of staff in France and our 28 subsidiaries worldwide. We are proud to illuminate 70% of French districts with over 5,000 inhabitants and more than 1,000 towns and cities and 500 shopping centres worldwide.

Above all, we strive to do our job with the same passion as on the very first day.

The richness of our company comes from the experience gained through discussions, listening and the creative solutions provided for our customers.

When it comes to illuminations in Sweden, the United States, France or Mexico, the expectations are often different. The adaptability and professionalism of our local teams therefore ensure that we are able to meet the needs of each city and the culture of each country.

The ultimate aim, whatever the location around the globe, is to arouse emotions with our illuminations...



- 
- 53 YEARS OF HISTORY AND HERITAGE
  - 1000 TOWNS ILLUMINATED IN OVER 80 COUNTRIES
  - 28 SUBSIDIARIES
- 

## Blachère KNOW-HOW

**For us, creation is key: it starts with a sketch, a drawing by hand, an idea, a dream... then our designers bring it to life in the form of light.**

We are more than just manufacturers; we are passionate creatives with a single mission: to enthral the world by telling beautiful stories through fairytale designs, innovative decorations and magical luminous settings.

We are inspired by all that surrounds us, and by anything that could stir an emotion... Being creative is not mutually exclusive with professional expertise: this philosophy keeps us one step ahead and sets us apart from the crowd. Thanks to our innovations, we are able to strike the right balance between age-old know-how and industrialisation.

This is demonstrated by the fact that we are the only company in our market to have received the **EPV living heritage company label**.

This distinction is awarded to companies with exceptional know-how, combining tradition and innovation.

From decorative ironwork to the most painstaking wiring, more than 7,000 made-to-measure decorations take shape in our workshops in France and abroad each year: the "Haute Couture" of illuminations. In parallel, standard decorations from our summer and winter "Ready-to-wear" collections are printed using eco-friendly materials thanks to our fleet of twelve large-scale 3D printers in France and elsewhere.

Although our expertise was born in France over 50 years ago, we are delighted to now have five production sites in Europe, the Middle East and America, which allow us to deliver to countries around the world via local supply chains and to contend with the economic demands of the market.

- 
- 15 000 DECORATIONS CRAFTED EACH YEAR
  - 5 PRODUCTION SITES AROUND THE WORLD
  - 500 PEOPLE IN OUR WORKSHOPS
- 



*our*  
SCHEMES



Londres, United Kingdom



Samobor, Croatia



Victoria Leeds, United Kingdom



Manchester, United Kingdom



Oslo, Norway



United Kingdom



Zadar, Croatia



Amsterdam, Netherlands



Newcastle, United Kingdom



Brezno, Slovakia

# our dna, INNOVATION

Innovation informs every dimension of Blachere Illumination, from materials and manufacturing to light itself.

Our research and development efforts place eco-friendly innovation at the forefront of our response to evolving environmental challenges.

Over twenty years ago, we led the way in rolling out low-energy LED technology across our entire range.

Robotic 3D printing has enabled the in-house production of our eco-friendly materials – Bioprint, Recyprint, and Flexiprint – for over a decade. Our manufacturing processes are fully patented. This shift has led to a substantial reduction in our carbon footprint, driven by a marked decrease in the use of aluminium across our decorations.

Our innovations have enabled us to strike the right balance between traditional craftsmanship and industrial scale.

- 1987: LIGHT WIRE PIONEERS
- 2002: WIDESPREAD ADOPTION OF LED TECHNOLOGY
- 2016: BIOPRINT INNOVATION
- 2021: RECYPRINT INNOVATION
- 2024: FLEXIPRINT INNOVATION
- 2025: OUR FIRST MADE IN EUROPE STRING LIGHT

## SPARKLIGHT® EUROPA

BY BLACHERE ILLUMINATION®



In 2025, a new challenge took shape: producing a high-quality string light at our Apt workshops in France, all without compromising our competitiveness. Full details on page 168.



## BIOPRINT



Bioprint is a bio-based material derived from GMO-free sugarcane, transformed into dehydrated bioethanol under the supervision of a French laboratory. Bioprint is recyclable at end of life and remains biodegradable should it enter the natural environment. Biodegradation refers to the natural decomposition of organic matter with no adverse impact on the environment.

- DERIVED FROM SUGARCANE
- 100% BIODEGRADABLE AND RECYCLABLE



## RECYPRINT



Six hundred billion bottles are produced each year, many of which end up in our oceans. We made the decision to transform this waste into luminous decorative installations. PET bottles collected through recycling schemes are processed and then fed into our 3D printers to create decorative installations in a wide range of colours. To date, over nine million bottles have been given a second life as decorative installations.

- MADE FROM RECYCLED PLASTIC BOTTLES
- 100% RECYCLABLE



## FLEXIPRINT



Flexiprint is an innovative, flexible, and recyclable material made from industrial production waste, redefining the finishing of 3D installations with a distinctive and contemporary aesthetic.

- MADE FROM RECYCLED PLASTIC
- 100% RECYCLABLE



# our commitment to THE ENVIRONMENT

**Illumination is only the starting point for us. Our commitment is to a beautiful, brighter, more responsible future.**

Founded in 1973 in the midst of the oil crisis, the company has never ceased to innovate in order to respond creatively to new environmental challenges.

From the early adoption of LED technology to today's recyclable, eco-responsible materials, we continue to redefine the design and life cycle of our illuminated designs.

Our environmental commitment continues to deepen. From 2026, solar energy will supply up to thirty percent of the production needs for our eco-friendly materials at our Apt site. Another meaningful step in our journey towards sustainable innovation.

- 35 000 RECONDITIONNED DECORATIONS EACH YEAR
- 9 MILLION BOTTLES GIVEN A SECOND LIFE
- 80% REDUCTION IN ALUMINIUM USED ACROSS OUR DECORATIONS



## ENERGY SAVINGS

### LOW-CONSUMPTION LEDS

All our displays, along with our garlands and projectors, are fitted with ultra-low-energy LEDs, using up to ten times less energy than traditional lighting.

### THE SOLAR ENERGY ALTERNATIVE

To help you tackle environmental concerns both creatively and pragmatically, some of our designs can be fitted with solar panels, making them completely self-sufficient.

### MANAGEMENT OF YOUR INSTALLATIONS

Smart energy management supports a broader vision of eco-responsible urban design. To ensure the optimal control of your illuminations, we offer a range of control units and fully integrated management systems, which are detailed in the accessories section at the end of the catalogue.



## ECO-FRIENDLY MATERIALS

### RECYCLED ALUMINIUM

The frames and supporting structures of our designs are made from aluminium, 70% of which is recycled.

### DESIGNED FOR CIRCULARITY

Our eco-responsible materials allow us to reduce the amount of aluminium used in our designs, thereby lowering our carbon footprint.



Made from GMO-free bio-based sugar cane. Biodegradable material.



Made from recycled plastic bottles. Recyclable material.



Made from recycled plastic. Recyclable material.



## DURABILITY & RECONDITIONED

### RECONDITIONED DECORATIONS:

Reconditioned installations: we offer our clients a wide range of fully refurbished installations, promoting a conscious and responsible approach without compromising on quality or value.

### CLEAN END-OF-LIFE OF DESIGNS

At Blachere, we are committed to: the repair, re-use, collection, and processing of electrical and electronic equipment. Bioprint, Recyprint, and Flexiprint products are recyclable and are reused.



# CSR at the heart of OUR APPROACH

**Openness and honesty. Our CSR policy is a continuation of the expertise we have acquired over the last 50 years. We have always been committed to doing our job to the highest standards. Everything we create to illuminate the world must respect our planet and those who inhabit it.**

This approach is reflected every day in the actions of our teams, in France and around the world.

«The goal is important, but the path you take to reach it matters even more,» as Jean-Paul Blachère taught us.

We are committed to creating a working environment that enables each employee to achieve their full potential. We endeavour to nurture, train, and support our staff, all while offering them opportunities to progress and learn.

Parity and equity are key to our success, and we are proud to have almost as many women as men in our teams.

As for social and professional integration, we offer a host of opportunities for people with disabilities and those who have been excluded from the workforce.



Launched in 2000, the United Nations Global Compact is the world's largest corporate social responsibility initiative. We have adhered to the Compact since 2023, and the principles of human rights, international labour norms, environmental protection, and the fight against corruption in all its forms are at the heart of our strategy.



French Fab, launched in 2017, is the French industry flagship. French Fab represents companies, economic players, institutions, and industrial sites located in France that are committed to developing French industry.



The certification highlights companies committed to the circular economy. It is awarded to manufacturers who incorporate recycled plastic materials into their production processes.



A commitment to inclusivity. A French community of companies committed to an inclusive society and a sustainable world, working to support human development, create shared value, and foster inclusive, sustainable growth.



The Coq Vert community is THE network committed to energy and ecological transition. This seal reflects our commitment to putting climate issues at the heart of our strategy.

# the blachère FOUNDATION

**Born from a passion for contemporary art and the African continent, our corporate foundation was established in 2004 by Jean-Paul Blachère and has since become Europe's first foundation dedicated to contemporary African art.**

It supports contemporary artistic creation from Africa and promotes artists from the continent through its 400 m<sup>2</sup> arts centre in Bonnieux, in the heart of the Luberon.

Our foundation hosts exhibitions and welcomes artists living in France and Africa. It takes part in major African Biennales, including that in Dakar.

Since its creation, the Foundation has supported more than five hundred artists, both women and men, emerging and famous, offering them a gateway into the wider world of contemporary art.



fondation Blachère

- 22 000 VISITORS TO THE FOUNDATION IN 2025
- 22 YEARS ROOTED IN PROVENCE
- 512 RESIDENT ARTISTS HOSTED

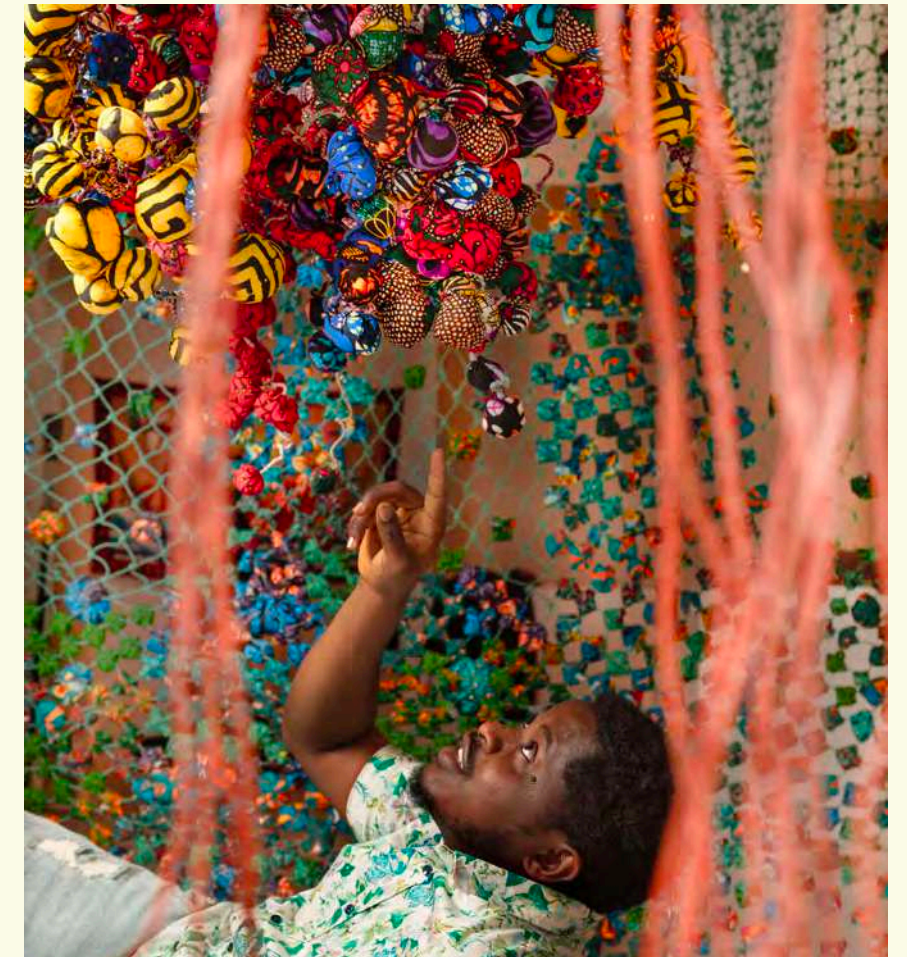



# VOLUMES

*& urban*

NEW COLLECTION

# L'ODYSSÉE

*Fantastique*

The Fantastic Odyssey draws inspiration from the world of fairy tales and enchanted forests. A universe inhabited by magical creatures: owls guarding secrets, dainty fawns, giant mushrooms... each figure evokes the magic of a hidden world that reveals itself only to those who still dare to dream. Fairy-tale escapism, halfway between nature and fantasy.

- FAIRY TALES
- ENCHANTED FOREST
- MAGICAL CREATURES
- FAIRYTALE
- NATURE

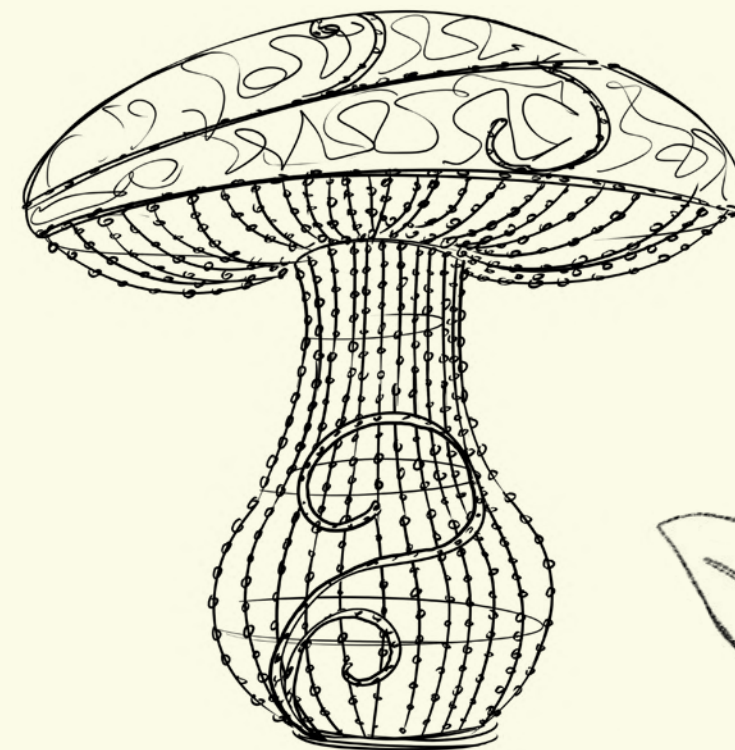
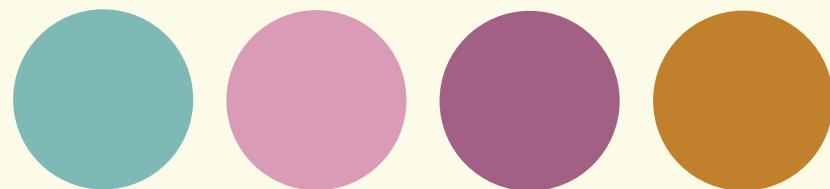
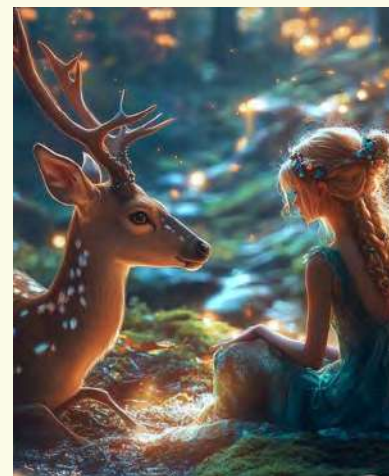



GX423L



GX426L



SC032RGB

LIGHTS RGBWW

GX428RGB

LIGHTS RGBWW



GX427RGB

LIGHTS RGBWW



GX425RGB

LIGHTS RGBWW



GX424L

GX423L - AYA					
◆ 1,56 m	◆ 1,9 m	◆ 0,84 m	▲ 31 kg	⚡ 28W	
■	■				FLASHY
NEW					

GX426L - TOD					
◆ 1 m	◆ 1,3 m	◆ 1 m	▲ 21 kg	⚡ 20W	
■	■				FLASHY
NEW					

SC032RGB - PIA					
◆ 2,30 m	◆ 1,9 m	◆	▲ 32 kg	⚡ 112W	
■					XLED-RGB
NEW					

RGBWW : colour-changing

GX428RGB - ODYSSEE RGB					
◆ 3 m	◆ 5 m	◆ 3 m	▲ 198 kg	⚡ 581W	
■					XLED-STARS-RGB
NEW					

RGBWW : colour-changing

GX427RGB - SLOW					
◆ 2,2 m	◆ 1,53 m	◆ 0,72 m	▲ 46 kg	⚡ 172W	
■					STARS-FLASHY-RGB
NEW					

RGBWW : colour-changing

GX425RGB - BIG TOD					
◆ 1,6 m	◆ 1,9 m	◆ 1,6 m	▲ 42 kg	⚡ 158W	
■					FLASHY-RGB
NEW					

RGBWW : colour-changing

GX424L - NAO					
◆ 1,93 m	◆ 1,5 m	◆ 0,89 m	▲ 37 kg	⚡ 30W	
■	■				FLASHY
NEW					



NEW COLLECTION

# SANTA EXPRESS

The imaginary world of travel, great explorations and distant discoveries is the inspiration here. Old maps, compasses, trains, majestic ships, and propeller planes... All symbols that evoke adventure and the promise of distant horizons. All set against the backdrop of winter enchantment, transforming each departure into a dazzling and magical tale.

TRAVEL  
DISCOVERY  
ADVENTURE  
EXPLORATION

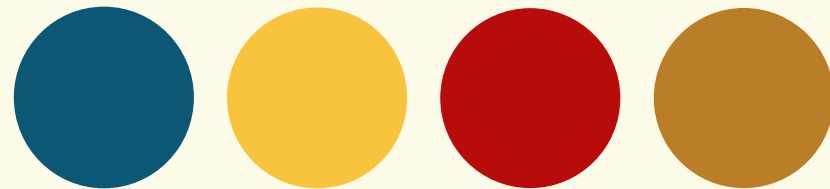
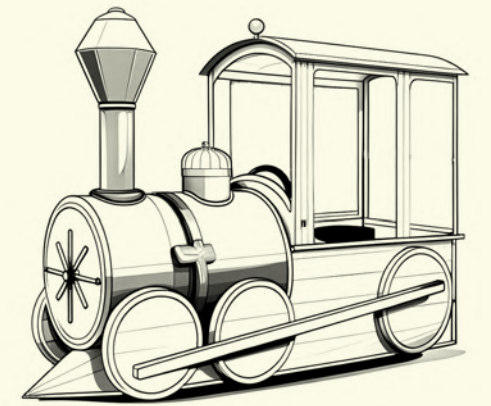
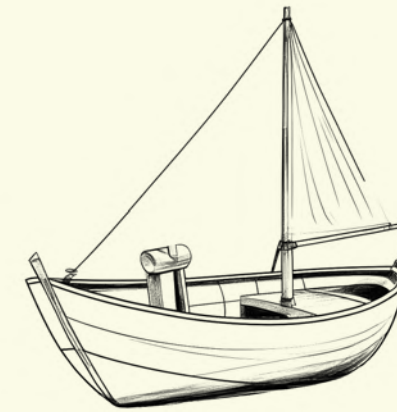
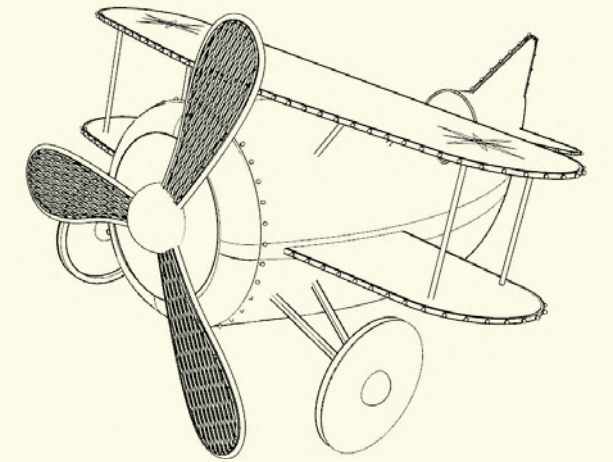

GX434L / GX434L-UK

GX422L

GX419L

GX421L

GX433L / GX433L-UK

GX193L

GX420L

**GX434L - CHRISTMAS CARD**

◆ 3 m ◆ 2,16 m ◆ 1,5 m ▲ 61 kg ↻ 134W  
 ■ STARS

**GX434L-UK - CHRISTMAS CARD EN**

◆ 3 m ◆ 2,16 m ◆ 1,5 m ▲ 61 kg ↻ 134W  
 ■ STARS

**NEW**

Customisation optional



**GX193L - FLASH**

◆ 2,35 m ◆ 1,25 m ◆ 0,96 m ▲ 42,5 kg ↻ 45W  
 ● FLASH-XLED-STARS

**GX419L - CAPTAIN CHRISTMAS**

◆ 2,2 m ◆ 2,9 m ◆ 1,36 m ▲ 78 kg ↻ 64 W  
 ■ STARS-FLASH

**NEW**



**GX421L - SANTA EXPRESS**

◆ 2,7 m ◆ 1,9 m ◆ 1 m ▲ 88 kg ↻ 214W  
 ■ XLED-STARS

**NEW**



**GX420L - AIR SANTA**

◆ 2,32 m ◆ 1,55 m ◆ 2,36 m ▲ 60 kg ↻ 176W  
 ■ XLED-STARS

**NEW**



**GX422L - CALYPSO**

◆ 2,35 m ◆ 2,3 m ◆ 1,2 m ▲ 43 kg ↻ 65W  
 ■ XLED-STARS

**NEW**



**GX433L - SANTA CARD**

◆ 3 m ◆ 2,16 m ◆ 1,5 m ▲ 61 kg ↻ 116W  
 ■ XLED

**GX433L-UK - SANTA CARD EN**

◆ 3 m ◆ 2,16 m ◆ 1,5 m ▲ 61 kg ↻ 116W  
 ■ XLED

**NEW**

Customisation optional



NEW COLLECTION

# ROYAUME DES GLACES

Inspiration comes from the lands of the Far North, where snow becomes a setting and ice, a palace. Each animal embodies the fragile poetry of these frozen lands. Soft silhouettes, gentle expressions, and velvety textures inspire a tender and protective sense of wonder. Here, nature becomes a story, and every creature seems to step out of a snow globe, perfectly frozen in wintry glory, yet ready to come to life the moment they meet a dreamy gaze.

SNOW  
PURITY  
SILHOUETTES  
SOFT CURVES  
ICE

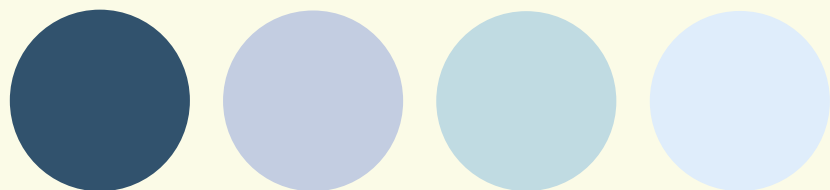
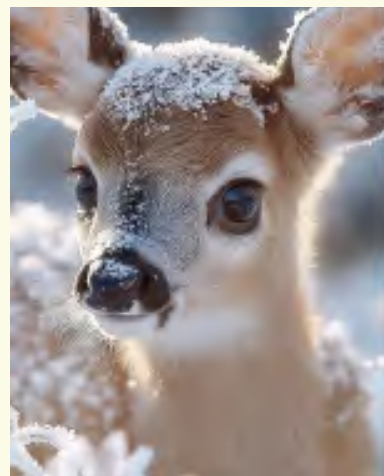
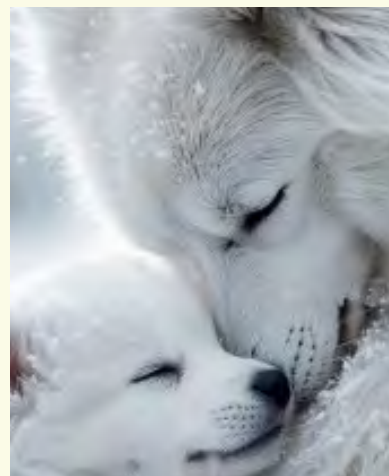



GX429L

GX428DC

GX431L

GX430L

2 IN 1 PRODUCTS!  
Dual color GX428DC (pure white/warm white)

GX429L - OLI SCENE					
◆ 2,3 m	◆ 1,9 m	◆ 0,3 m	▲ 30 kg	⚡ 70W	
■	●				
NEW					

GX428DC - ODYSSEÉ					
◆ 3 m	◆ 5 m	◆ 3 m	▲ 180 kg	⚡ 301W	
■	●				
NEW					

GX431L - OLI					
◆ 1,55 m	◆ 1,25 m	◆ 0,3 m	▲ 16 kg	⚡ 30W	
■	●				
NEW					

GX430L - PINGOO					
◆ 1,68 m	◆ 1,8 m	◆ 0,3 m	▲ 28 kg	⚡ 70W	
■	●				
NEW					





**GX356L - ICE**  
 ◀ 1,5 m ▶ 1,8 m ▣ 1 m ▲ 19,5 kg ↻ 25W  
 ● FLASH

**GX346L - TIPI CRISTAL**  
 ◀ 1,2 m ▶ 2,3 m ▣ 1,2 m ▲ 30 kg ↻ 65W  
 ● FLASH

**SL053W - KADO**  
 ◀ 0,8 m ▶ 1,15 m ▣ 0,8 m ▲ 14 kg ↻ 20W  
 ● ●

**GX354LW - LUX**  
 ◀ 3,6 m ▶ 3,7 m ▣ ▲ 130 kg ↻ 165W  
 ● SOFT XLED

**SL051W - FONTAIN CRISTAL**  
 ◀ 4 m ▶ 2,8 m ▣ 4 m ▲ 63,4 kg ↻ 145W  
 ● SOFT XLED

**GX348L - SANTA CRISTAL**  
 ◀ 1,93 m ▶ 2,9 m ▣ 1,37 m ▲ 66 kg ↻ 40W  
 ● FLASH





**GX347L - WIZZ CRISTAL**  
 ◆ 2,3 m ◆ 1,2 m ◆ 1,2 m ▲ 69 kg ↻ 85W  
 ● FLASH

**GX344L - SCALA**  
 ◆ 2,9 m ◆ 5 m ◆ 2,9 m ▲ 315 kg ↻ 175W  
 ● FLASH

**GX349L - FROST**  
 ◆ 2,55 m ◆ 1,5 m ◆ 1,05 m ▲ 42 kg ↻ 45W  
 ● FLASH

**SL052W - DEMI ARCHE CRISTAL**  
 ◆ 1 m ◆ 2,53 m ◆ 1 m ▲ 22,5 kg ↻ 45W  
 ● FLASH

**SL052W - DEMI ARCHE CRISTAL**  
 ◆ 1 m ◆ 2,53 m ◆ 1 m ▲ 22,5 kg ↻ 45W  
 ● FLASH

**GX357L - CHRIS**  
 ◆ 1,5 m ◆ 2,3 m ◆ 1 m ▲ 37,5 kg ↻ 20W  
 ● FLASH

**GX345L - CRISTAL**  
 ◆ 2,14 m ◆ 3,14 m ◆ 1,15 m ▲ 47 kg ↻ 70W  
 ● FLASH





GX333L

SL053W

SL053W - KADO

◆ 0,8 m ◆ 1,15 m ▣ 0,8 m ▲ 14 kg ↻ 20W  
 ● ●

GX333L - HAPPY SANTA

◆ 2,5 m ◆ 2,56 m ▣ 1,5 m ▲ 70 kg ↻ 30W  
 ● ● FLASH



GX087L

GX265LW

GX163L

GX087L - LITTLE TEDDY CHIC

◆ 2 m ◆ 2 m ▣ 1,45 m ▲ 54 kg ↻ 46W  
 ● ● FLASH

GX265LW - LOLLIPOP

◆ 1,28 m ◆ 2 m ▣ 1,28 m ▲ 31,5 kg ↻ 50W  
 ● ● FLASH

GX163L - ELIOTT

◆ 2,02 m ◆ 2,8 m ▣ 1,25 m ▲ 32 kg ↻ 20W  
 ● ● FLASH





GX308L - LETTERBOX  
 ◆ 0,9 m ◆ 2 m ▣ 0,9 m ▲ 43,5 kg ⚡ 172W  
 ● STARS-FLASH

SV504A - DAVE A  
 ◆ 1,6 m ◆ 3,12 m ▣ 1,6 m ▲ 44,5 kg ⚡ 35W  
 ● FLASH

GX148L - MAX  
 ◆ 1,8 m ◆ 2,2 m ▣ 1,37 m ▲ 128,5 kg ⚡ 33W  
 ● FLASH

GX153L - CANDY SELFIE  
 ◆ 1,9 m ◆ 1,96 m ▣ 1 m ▲ 59 kg ⚡ 39W  
 ● STARS-FLASH

GX132L - MISTER XMAS  
 ◆ 2,6 m ◆ 3,6 m ▣ 1,9 m ▲ 97 kg ⚡ 74W  
 ●

SL038W - KDO  
 ◆ 0,9 m ◆ 1,3 m ▣ 0,9 m ▲ 17,5 kg ⚡ 20W  
 ●

SL038R - KDO  
 ◆ 0,9 m ◆ 1,3 m ▣ 0,9 m ▲ 17,5 kg ⚡ 20W  
 ●





**GX261LW - TRADI BOX**  
 ◆ 1,23 m ◆ 1,9 m ▣ 0,66 m ▲ 32,5 kg ⚡ 60W  
 ● FLASH-STAR

**GX093L - RENNOO**  
 ◆ 1,2 m ◆ 2 m ▣ 0,6 m ▲ 52 kg ⚡ 18W  
 ● FLASH

**GX092L - CUTE RENNOO**  
 ◆ 1,15 m ◆ 2,2 m ▣ 0,76 m ▲ 99 kg ⚡ 18W  
 ● FLASH



**SOCL43 - ASTRAL BOOTH**  
 ◆ 1,6 m ◆ 2,2 m ▣ 0,8 m ▲ 20,4 kg ⚡ 25W  
 ● FLASH

**GX260LW - ELY**  
 ◆ 1,1 m ◆ 1,5 m ▣ 1 m ▲ 7,1 kg ⚡ 20W  
 ● STARS

**GX260L - ELY**  
 ◆ 1,1 m ◆ 1,5 m ▣ 1 m ▲ 7,1 kg ⚡ 20W  
 ● STARS

**SL038W - KDO**  
 ◆ 0,9 m ◆ 1,3 m ▣ 0,9 m ▲ 17,5 kg ⚡ 20W  
 ● FLASH

**SL038R - KDO**  
 ◆ 0,9 m ◆ 1,3 m ▣ 0,9 m ▲ 17,5 kg ⚡ 20W  
 ● FLASH





**GX151L - ROY**  
 ◆ 1 m ◆ 2 m ■ 1 m ▲ 27 kg ↻ 17W  
 ● FLASH

**SOCL47 - TRADI PHOTOBOOTH**  
 ◆ 1,75 m ◆ 2,45 m ■ 0,8 m ▲ 21,5 kg ↻ 15W  
 ● FLASH

**GX152L - ED**  
 ◆ 1,48 m ◆ 2 m ■ 0,85 m ▲ 27,5 kg ↻ 12W  
 ● FLASH



**1 INSTALLATION, 2 COLOURS OPTION!**  
 The DUO COMÈTE installation (GX118DC) offers a choice of warm white or pure white. Reverse the connector to opt for either the pure white/pure white flash or warm white/warm white flash option.



**GX194L - WIZZ**  
 ◆ 2,3 m ◆ 1,2 m ■ 1,2 m ▲ 82 kg ↻ 79W  
 ● XLED-STARS-FLASH

**GX118DC - DUO COMETE**  
 ◆ 2,18 m ◆ 2,6 m ■ 1,2 m ▲ 27,4 kg ↻ 35W  
 ● FLASH





**GX263L - THEODOR**  
 ◆ 0,66 m ◆ 2,3 m ▣ 0,9 m ▲ 25,5 kg ↻ 20W  
 ● FLASH

**GX358L - ALEX**  
 ◆ 2,35 m ◆ 3,74 m ▣ 1,88 m ▲ 71 kg ↻ 50W  
 ● FLASH-STARS

**GX102LW - XMAS TRAIN**  
 ◆ 3,55 m ◆ 1,9 m ▣ 1 m ▲ 130 kg ↻ 124W  
 ● FLASH-XLED

**GX247L-A - BOX**  
 ◆ 1,7 m ◆ 2,2 m ▣ 0,9 m ▲ 90,5 kg ↻ 130W  
 ● STARS-XLED

**GX264LW - BIGS**  
 ◆ 1,9 m ◆ 1,6 m ▣ 0,8 m ▲ 67,5 kg ↻ 75W  
 ● FLASH

**GX244L - LOLITA**  
 ◆ 2,13 m ◆ 2,3 m ▣ 1,61 m ▲ 53 kg ↻ 35W  
 ● FLASH

**GX267LW - CIRCUS**  
 ◆ 1,8 m ◆ 3 m ▣ 1,8 m ▲ 81 kg ↻ 160W  
 ● FLASH





GX262LW



GX159L



GX248LR

GX262LW - YUMMY				
1,3 m	1,6 m	0,3 m	17 kg	35W
FLASH				

GX159L - DOUDOU				
1,94 m	2,1 m	1,19 m	39,5 kg	28W
FLASH				

GX248LR - SUGAR				
0,8 m	2 m	0,8 m	27,5 kg	5W
FLASH				



GX105L

GX164L



GX119L

GX118L



GX249L / GX249L-A

GX105L - TOMMY				
2,5 m	2,7 m	2,2 m	91 kg	50W
FLASH				

GX119L - ROMY				
3 m	4,5 m	2,45 m	81 kg	29W
FLASH				

GX164L - WIZZ SANTA				
3,8 m	2,3 m	1,2 m	66 kg	25W
FLASH				

GX249L - RAYMOND				
1,5 m	2,2 m	0,84 m	37 kg	20W
FLASH				

GX118L - COMETE				
2,18 m	2,6 m	1,2 m	27,4 kg	14W
FLASH				

GX249L-A - RAYMOND				
1,5 m	2,2 m	0,84 m	44 kg	20W
INTERACTIVITE				





**GX086L - TEDDY CHIC**  
 ◆ 4,02 m ◆ 4 m ▣ 2,82 m ▲ 157 kg ↻ 208W  
 ● FLASH

**SL135W - ASTRAL ARCH**  
 ◆ 4,93 m ◆ 3,75 m ▣ 1 m ▲ 88 kg ↻ 80W  
 ● FLASH-XLED

**GX133L - MISTER SANTA**  
 ◆ 1,76 m ◆ 2,8 m ▣ 1,4 m ▲ 125 kg ↻ 46W  
 ●

**GX086L-A - TEDDY CHIC**  
 ◆ 4,02 m ◆ 4 m ▣ 2,82 m ▲ 172 kg ↻ 248W  
 ● INTERACTIVITE-FLASH

**TO ORDER**  
 GX086L-A with presence detector



**SL037W - DEMI ARCHE COMETE**  
 ◆ 1,1 m ◆ 2,9 m ▣ 1 m ▲ 24 kg ↻ 20W  
 ● FLASH

**SL045V - VERDE**  
 ◆ 2,25 m ◆ 3 m ▣ 2,25 m ▲ 45,5 kg ↻ 180W  
 ● XLED

**GX098L - JOHN**  
 ◆ 1,5 m ◆ 2,3 m ▣ 0,9 m ▲ 56 kg ↻ 30W  
 ●





GX262LW

GX256LW

GX172LW

GX245LW

GX350LW

GX257LW

GX259LW

GX258LW

GX262LW - YUMMY					
1,3 m	1,6 m	0,3 m	17 kg	35W	
FLASH					

GX256LW - ANGEL					
1,63 m	1,83 m	0,3 m	21 kg	55W	
FLASH					

GX257LW - CLEM					
1,21 m	1,49 m	0,3 m	17,5 kg	30W	
FLASH					

GX172LW - JOSÉ					
1,2 m	2,15 m	0,3 m	15 kg	40W	
FLASH					

GX259LW - CLEO					
1,33 m	1,5 m	0,3 m	21 kg	50W	
FLASH					

GX245LW - MANALA					
1,34 m	1,88 m	0,3 m	19,5 kg	45W	
FLASH					

GX258LW - KRYS					
1,27 m	1,17 m	0,3 m	17 kg	55W	
FLASH					

GX258L - KRYS					
1,27 m	1,17 m	0,3 m	17 kg	55W	
FLASH					

GX350LW - JOSE SCENE					
2,35 m	2 m	0,5 m	37 kg	85W	
XLED					



GX145L / GX145L-A

SOCL42

GX160L

GX206L

GX149L

GX147L

GX079L

GX205L



<b>GX145L - NOAH</b>
◆ 2,27 m ◆ 3 m ▣ 1,84 m ▲ 76 kg ↻ 54W
● FLASH
<b>GX145L-A - NOAH ANIME</b>
◆ 2,27 m ◆ 3 m ▣ 1,84 m ▲ 100 kg ↻ 54W
● INTERACTIVITE-FLASH-XLED
<b>TO ORDER</b>
GX145L-A with buzzer

<b>GX160L - PINGU</b>
◆ 1,94 m ◆ 2,08 m ▣ 1,16 m ▲ 31 kg ↻ 20W
● FLASH

<b>SOCL42 - BLIZZARD PHOTOBOOTH</b>
◆ 1,6 m ◆ 2,2 m ▣ 0,8 m ▲ 18,5 kg ↻ 25W
●

<b>GX206L - BABY BEAR</b>
◆ 1,4 m ◆ 1,5 m ▣ 1,3 m ▲ 30,4 kg ↻ 40W
●

<b>GX205L - DADDY BEAR</b>
◆ 2,2 m ◆ 1,5 m ▣ 0,7 m ▲ 27 kg ↻ 22W
●

<b>GX149L - FROZEN LETTERBOX</b>
◆ 1,1 m ◆ 2 m ▣ 1,1 m ▲ 36 kg ↻ 49W
● STARS-FLASH

<b>GX079L - ICE IGLOO</b>
◆ 2,2 m ◆ 1,5 m ▣ 2 m ▲ 55 kg ↻ 64W
● FLASH

<b>GX147L - FOX</b>
◆ 1,75 m ◆ 2,2 m ▣ 1,4 m ▲ 37 kg ↻ 20W
● FLASH



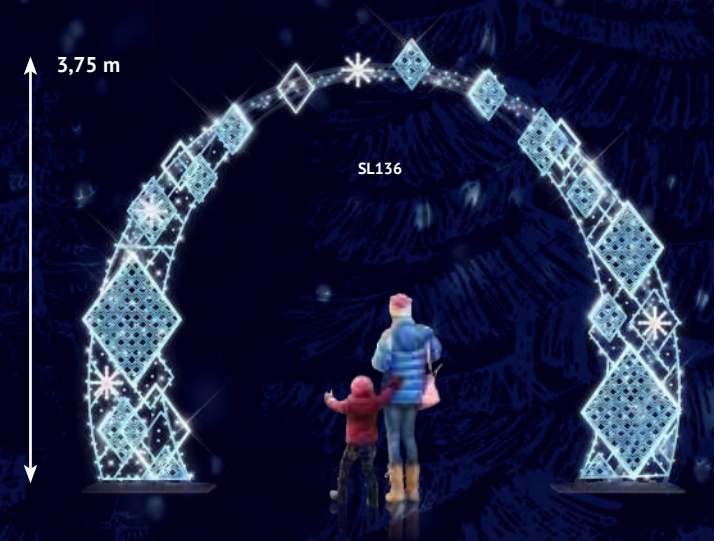
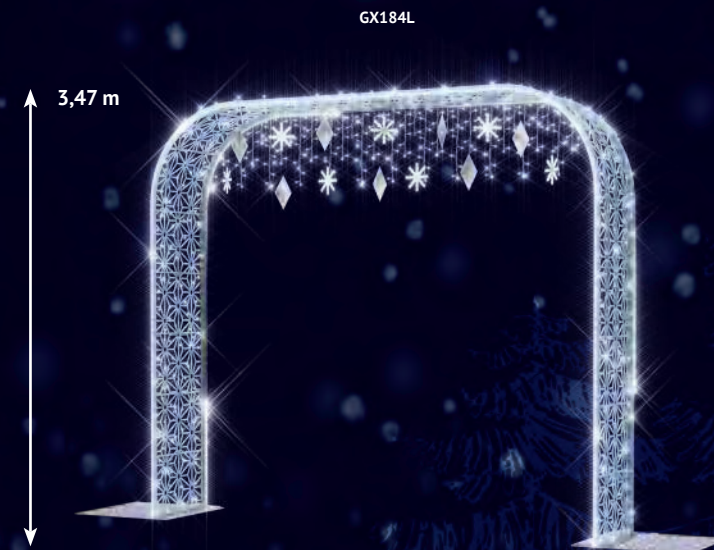

2 IN 1 PRODUCTS! Dual color SL055DC (pure white/warm white)



**GX184LW - GOLD ARCH**  
 ◆ 5,82 m ◆ 3,47 m ◆ 0,95 m ◆ 115 kg ◆ 100W  
 FLASH-FL900-COMETE  
**TO ORDER**

**SL136W - QUADRILLE ARCH**  
 ◆ 4,93 m ◆ 3,75 m ◆ 1 m ◆ 81,5 kg ◆ 60W  
 XLED-FL900E-FLASH  
**TO ORDER**

**GX184L - BLIZZARD ARCH**  
 ◆ 5,82 m ◆ 3,47 m ◆ 0,95 m ◆ 115 kg ◆ 100W  
 FLASH-FL900-COMETE  
**TO ORDER**

**SL136 - QUADRILLE ARCH**  
 ◆ 4,93 m ◆ 3,75 m ◆ 1 m ◆ 81,5 kg ◆ 60W  
 FLASH-FL900-COMETE  
**TO ORDER**

**GX252L - TRADI ARC**  
 ◆ 5,88 m ◆ 4,58 m ◆ 0,99 m ◆ 382 kg ◆ 568W  
 STARS-FL900-FLASH  
**TO ORDER**

**SL055DC - COSY ARCH**  
 ◆ 2,38 m ◆ 2,95 m ◆ 0,15 m ◆ 52 kg ◆ 11W  
 FLASHY  
**NEW**

**GX252LW - TRADI ARC**  
 ◆ 5,88 m ◆ 4,58 m ◆ 0,99 m ◆ 382 kg ◆ 568W  
 STARS-FL900-FLASH  
**TO ORDER**

**SL135W - ASTRAL ARCH**  
 ◆ 4,93 m ◆ 3,75 m ◆ 1 m ◆ 88 kg ◆ 80W  
 FLASH-XLED  
**TO ORDER**





SL050R - LOVE ARCH  
 ◆ 6,2 m ◆ 4 m ▣ 0,7 m ▲ 219 kg ↻ 150W  
 ■ ● ●  
 TO ORDER

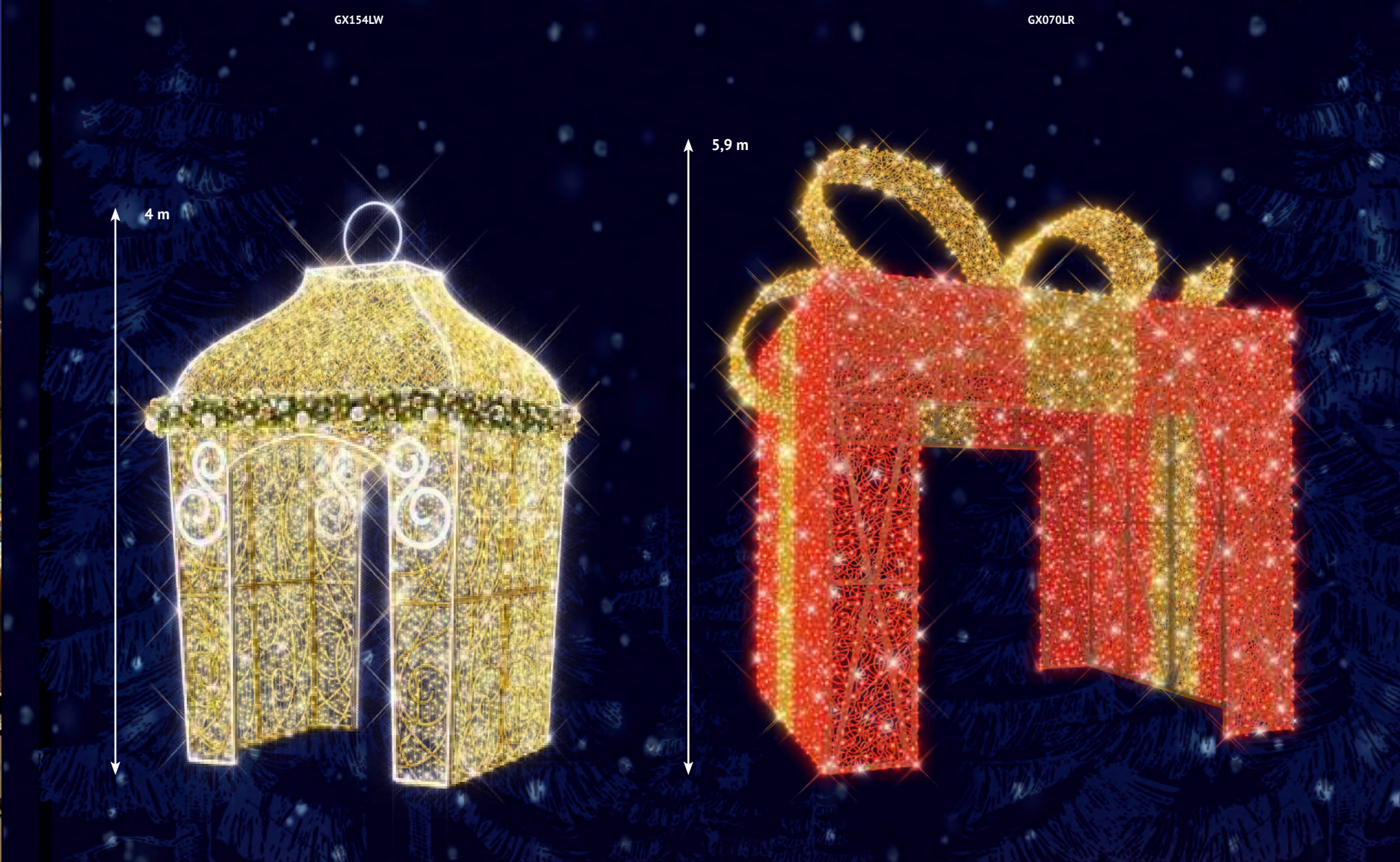

GX154LW - LUMI  
 ◆ 2 m ◆ 4 m ▣ 1,8 m ▲ 171 kg ↻ 135W  
 ■ ● ● FLASH

GX070LR - TITAN  
 ◆ 3,6 m ◆ 3,9 m ▣ 3,3 m ▲ 235 kg ↻ 260W  
 ■ ● ● FLASH  
 TO ORDER





**GX432LR - VICTORIA**  
 ◆ 3,46 m ◆ 3,73 m ◆ 3,2 m ◆ 213 kg ◆ 256W  
 ■ XLED-FLASHY  
**NEW**

**GX432LW - VICTORIA**  
 ◆ 3,46 m ◆ 3,73 m ◆ 3,2 m ◆ 213 kg ◆ 256W  
 ■ XLED-FLASHY  
**NEW**

**GX155LW - ELIE**  
 ◆ 4 m ◆ 4,22 m ◆ 4 m ◆ 386 kg ◆ 382W  
 ■ XLED-STARS-FLASH

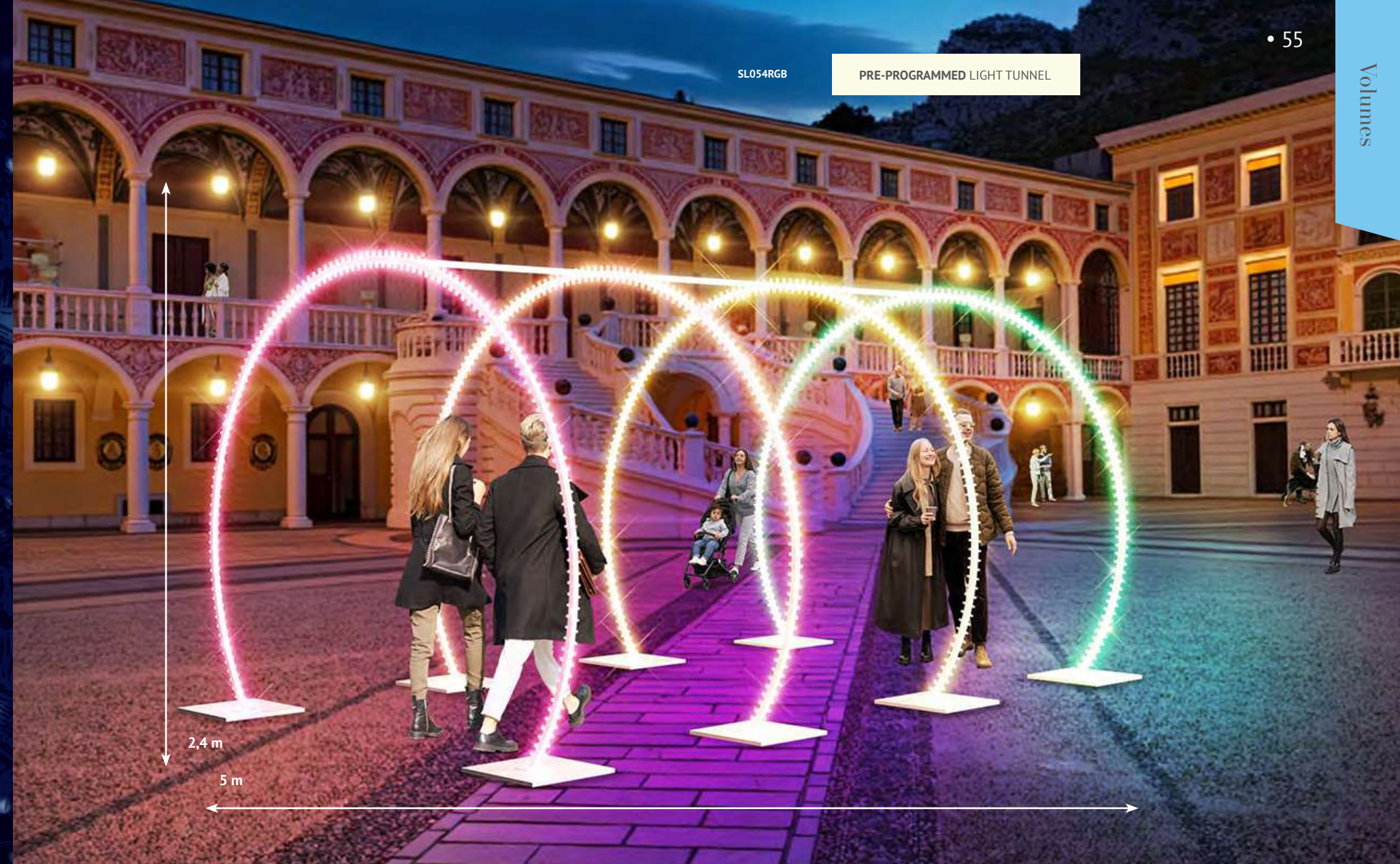

SL054RGB

PRE-PROGRAMMED LIGHT TUNNEL

2,4 m  
5 m

**SL054RGB - AURORA**  
 ◆ 5 m ◆ 2,4 m ◆ 3 m ◆ 76 kg ◆ 128W  
 ■ RGB  
**NEW**  
 TO ORDER

Comprising 4 RGBWW LED arches, this tunnel forms an immersive installation with a total length of 5 m. Animation is pre-programmed, ensuring a vivid and fully immersive visual experience. Simply plug it in and enjoy the show!



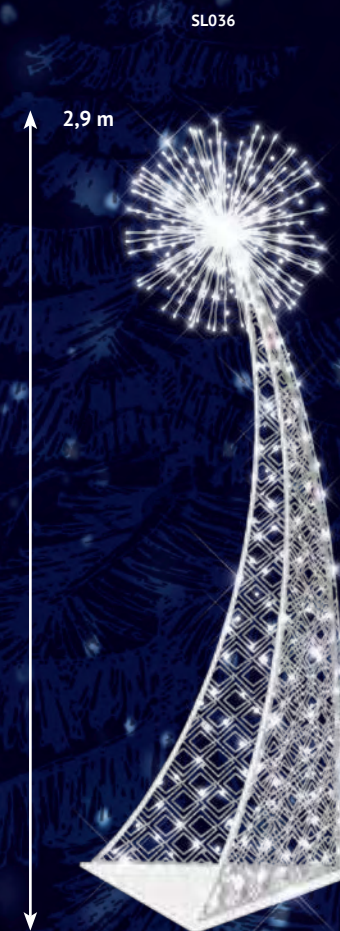

SL051W - FONTAIN CRISTAL  
 ◆ 4 m ◆ 2,8 m ◆ 4 m ▲ 63,4 kg ⚡ 145W  
 ● ● SOFT XLED

SL044W - ASTRAL FONTAIN  
 ◆ 4 m ◆ 2 m ◆ 4 m ▲ 82 kg ⚡ 120W  
 ● ● FLASH-COMETE

SL035W - TATIANA  
 ◆ 2,1 m ◆ 2 m ◆ 0,6 m ▲ 22,5 kg ⚡ 60W  
 ● ● COMETE-FLASH

SL036 - DEMI ARCHE FEU D'ARTIFICE  
 ◆ 1 m ◆ 2,9 m ◆ 0,9 m ▲ 32 kg ⚡ 21W  
 ● ● FLASH

SL036W - DEMI ARCHE FEU D'ARTIFICE  
 ◆ 1 m ◆ 2,9 m ◆ 0,9 m ▲ 32 kg ⚡ 21W  
 ● ● FLASH

SL037W - DEMI ARCHE COMETE  
 ◆ 1 m ◆ 2,9 m ◆ 1 m ▲ 24 kg ⚡ 20W  
 ● ● FLASH

SL052W - DEMI ARCHE CRISTAL  
 ◆ 1 m ◆ 2,53 m ◆ 1 m ▲ 22,5 kg ⚡ 45W  
 ● ● FLASH





<b>GX327L - BOULE XMAS</b>					
◆ 1 m	◆ 1,1 m	■ 1 m	▲ 6,6 kg	⚡ 25W	
● FLASH					⏸

<b>GX327LW - BOULE XMAS</b>					
◆ 1 m	◆ 1,1 m	■ 1 m	▲ 6,6 kg	⚡ 25W	
● FLASH					⏸

<b>GX156LW - SELFIE TREE</b>					
◆ 2,2 m	◆ 2,47 m	■ 0,9 m	▲ 53,5 kg	⚡ 15W	
● FLASH					⏸

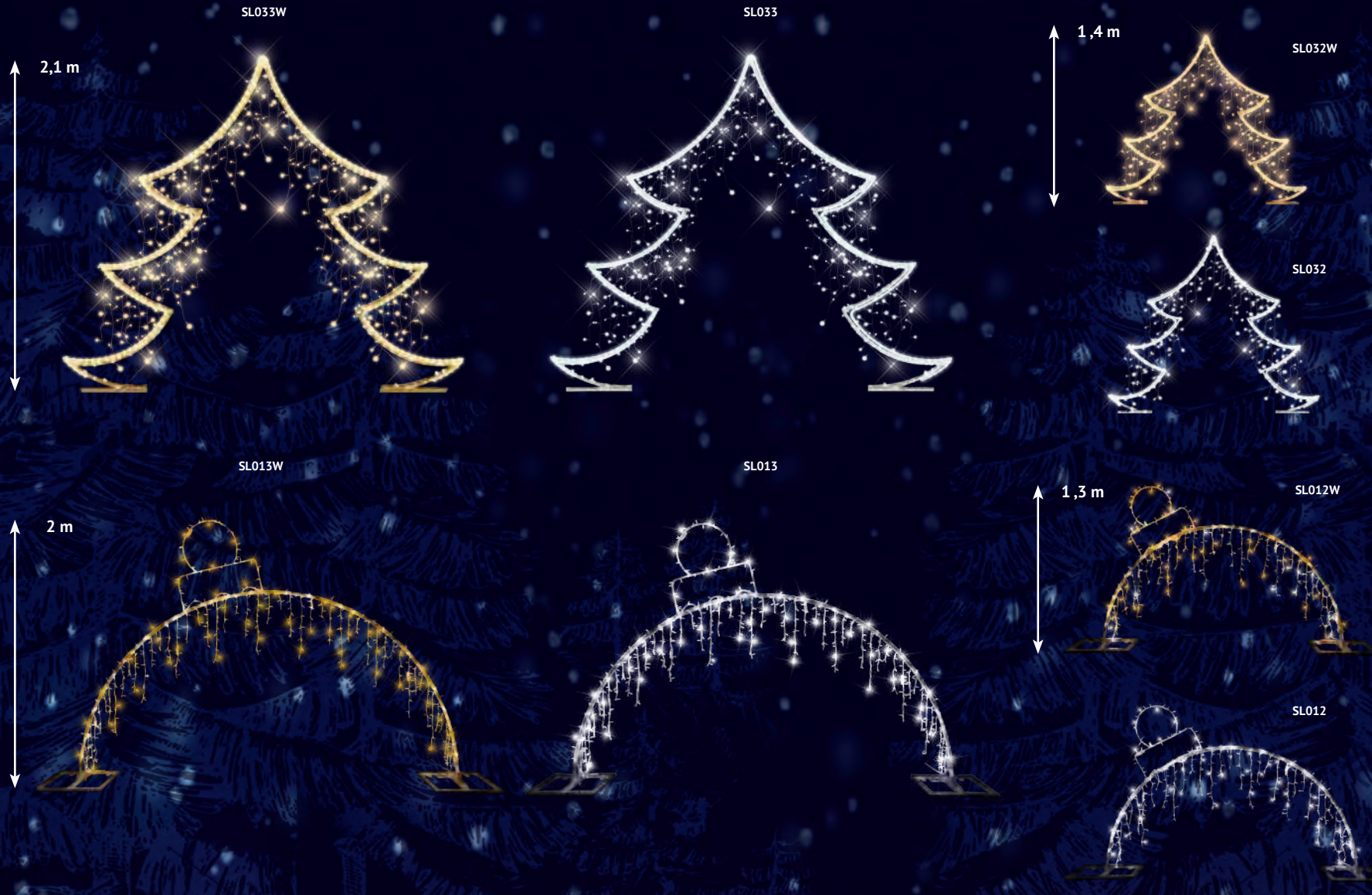

<b>SL033W - SYLVESTRE GM</b>					
◆ 2,5 m	◆ 2,1 m	■	▲ 8,8 kg	⚡ 45W	
● FLASH					⏸

<b>SL033 - SYLVESTRE GM</b>					
◆ 2,5 m	◆ 2,1 m	■	▲ 8,8 kg	⚡ 45W	
● FLASH					⏸

<b>SL032W - SYLVESTRE PM</b>					
◆ 1,4 m	◆ 1,4 m	■ 1,65 m	▲ 7,5 kg	⚡ 40W	
● FLASH					⏸

<b>SL032 - SYLVESTRE PM</b>					
◆ 1,65 m	◆ 1,4 m	■	▲ 7,5 kg	⚡ 40W	
● FLASH					⏸

<b>SL013W - PROXIMA GM</b>					
◆ 3,5 m	◆ 2 m	■	▲ 6 kg	⚡ 45W	
● FLASH					⏸

<b>SL013 - PROXIMA GM</b>					
◆ 3,5 m	◆ 2 m	■	▲ 6 kg	⚡ 45W	
● FLASH					⏸

<b>SL012 - PROXIMA PM</b>					
◆ 2,5 m	◆ 1,3 m	■	▲ 6,4 kg	⚡ 25W	
● FLASH					⏸

<b>SL012W - PROXIMA PM</b>					
◆ 2,5 m	◆ 1,3 m	■	▲ 6,4 kg	⚡ 5W	
● FLASH					⏸



GX173L

GX173LW

SL005W

GX185LW

5,22 m



5 m



2,5 m



3,5 m

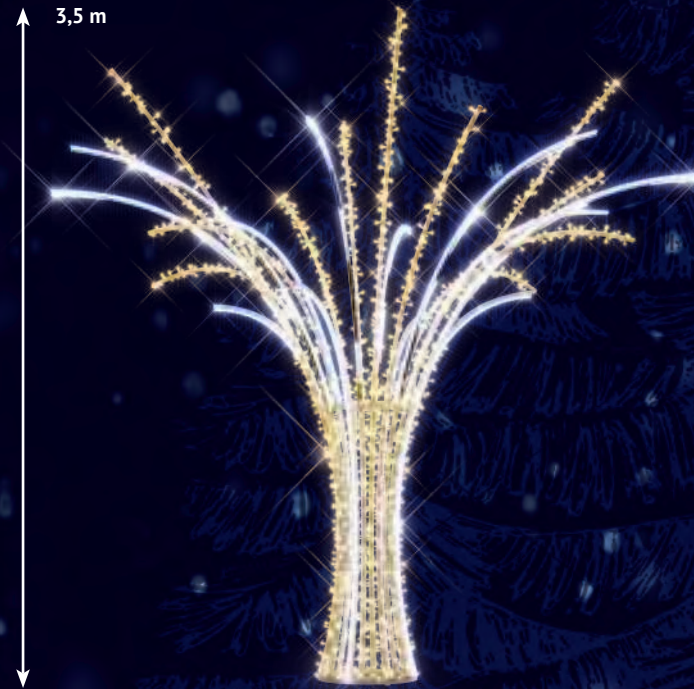

1 INSTALLATION, 2 COLOURS OPTION!  
The MINI MAGIC installation (GX266DC) offers a choice of warm white or pure white. Reverse the connector to opt for either the pure white/pure white flash or warm white/warm white flash option.

GX173L - MAGIC					
5 m	5,22 m	5 m	175 kg	290W	
					SOFT XLED-FLASH
TO ORDER					

GX173LW - MAGIC					
5 m	5,22 m	5 m	175 kg	290W	
					SOFT XLED-FLASH

SL005W - BJORK TREE BLANC CHAUD					
3,3 m	5 m	3,3 m	205 kg	100W	
					FLASH

GX266DC - MINI MAGIC					
1,6 m	2,5 m	1,6 m	28,5 kg	90W	
					XLED

GX185LW - LINA					
3,86 m	3,53 m	3,86 m	60 kg	140W	
					XLED



GX354L



GX354LW



GX355LW



GX344L



BALLASTS SOLD SEPARATELY

GX344LW



BALLASTS SOLD SEPARATELY

GX354L - LUX					
◆ 3,6 m	◆ 3,7 m	■	▲ 130 kg	↺ 165W	
●	●	●	●	●	●
SOFT XLED					

GX354LW - LUX					
◆ 3,6 m	◆ 3,7 m	■	▲ 130 kg	↺ 165W	
●	●	●	●	●	●
SOFT XLED					

GX355LW - GRACE TREE					
◆ 2 m	◆ 2,4 m	■ 2 m	▲ 34 kg	↺ 64W	
●	●	●	●	●	●
SOFT XLED					

GX344L - SCALA					
◆ 2,9 m	◆ 5 m	■ 2,9 m	▲ 315 kg	↺ 175W	
●	●	●	●	●	●
FLASH					

GX344LW - SCALA					
◆ 2,9 m	◆ 5 m	■ 2,9 m	▲ 315 kg	↺ 175W	
●	●	●	●	●	●
FLASH					



SLED010W



SND017

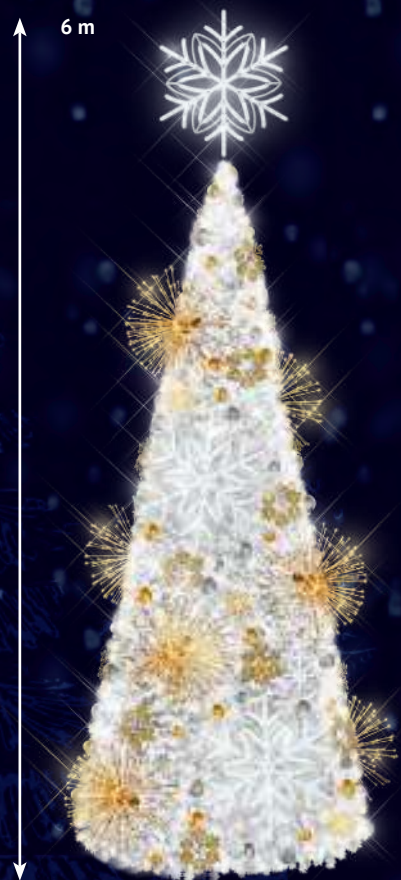

SV502W

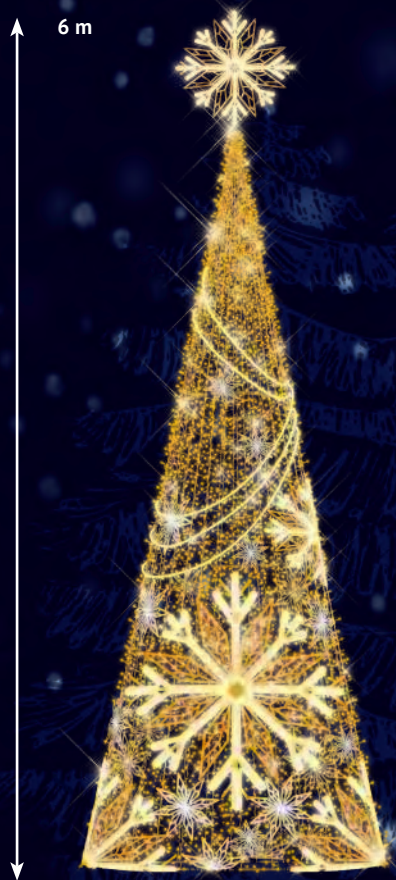

SV302W

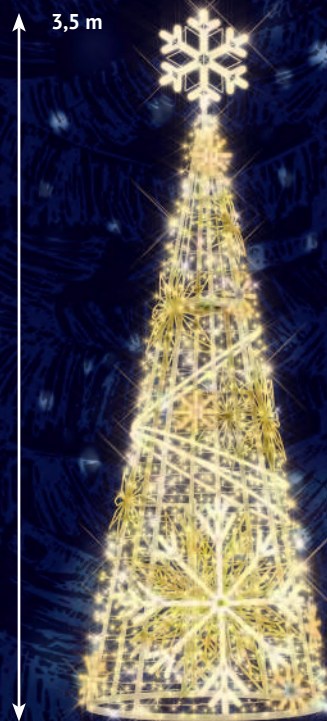

SV502



SV302

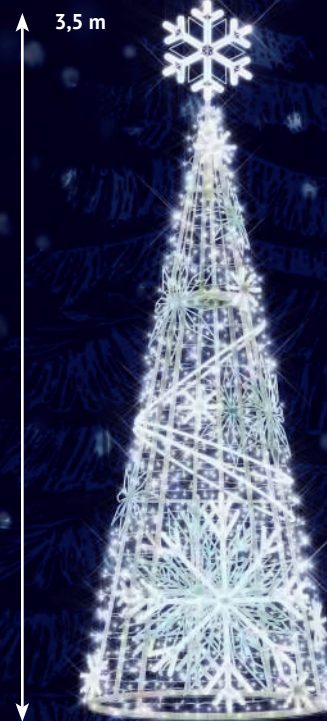

SLED010W - MARINA  
 ◆ 3,4 m ◆ 7,5 m ■ 3,4 m ▲ 152 kg ↺ 265W  
 ● FLASH  
 TO ORDER

SND017 - GRAND VEGA FROZEN  
 ◆ 2,2 m ◆ 6,25 m ■ 2,2 m ▲ 170 kg ↺ 275W  
 ● STARS/FLASH  
 TO ORDER

SV502W - CELESTE  
 ◆ 1,9 m ◆ 6 m ■ 1,9 m ▲ 97 kg ↺ 185W  
 ● FLASH  
 TO ORDER

SV302W - PETIT CELESTE  
 ◆ 1,16 m ◆ 3,5 m ■ 1,16 m ▲ 34 kg ↺ 70W  
 ● FLASH/STARS  
 TO ORDER

SV502 - CELESTE  
 ◆ 1,9 m ◆ 6 m ■ 1,9 m ▲ 97 kg ↺ 185W  
 ● FLASH/STARS  
 TO ORDER

SV302 - PETIT CELESTE  
 ◆ 1,16 m ◆ 3,5 m ■ 1,16 m ▲ 34 kg ↺ 70W  
 ● FLASH/STARS  
 TO ORDER



SV303W

SV303

SL048

SL049W

GX253LW

GX251L

GX251LW

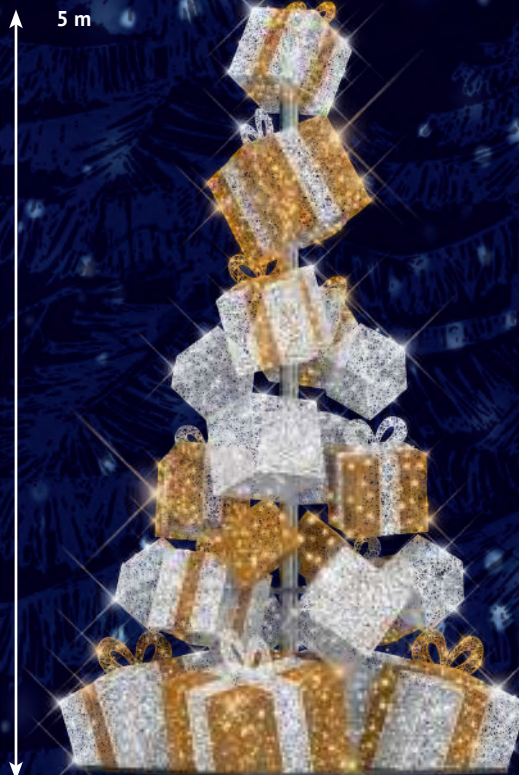
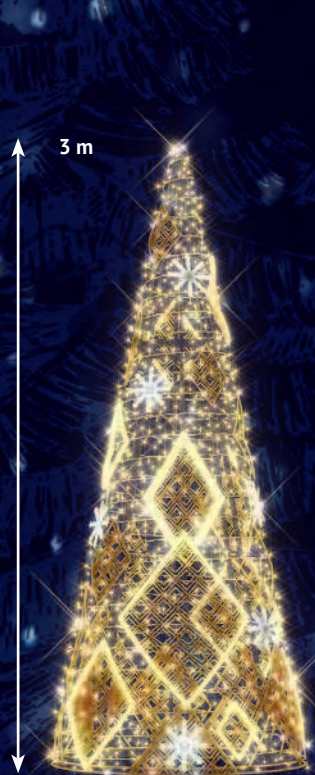

SV303W - QUADRI TREE  
 ◆ 1,16 m ◆ 3 m ▣ 1,16 m ▲ 30 kg ↻ 55W  
 ■ FLASH/STARS

SV303 - QUADRI TREE  
 ◆ 1,16 m ◆ 3 m ▣ 1,16 m ▲ 30 kg ↻ 55W  
 ■ FLASH/STARS

SL048 - EMY  
 ◆ 3 m ◆ 5 m ▣ 1,5 m ▲ 74,5 kg ↻ 150W  
 ■ FLASH-STAR

SL049W - JUDY  
 ◆ 3 m ◆ 5 m ▣ 1,5 m ▲ 70 kg ↻ 75W  
 ■ FLASH-STAR

GX253LW - TOM  
 ◆ 2,3 m ◆ 5 m ▣ 2,3 m ▲ 282 kg ↻ 120W  
 ■ FLASH

GX251L - BUBBLE  
 ◆ 2,5 m ◆ 5 m ▣ 2,5 m ▲ 245 kg ↻ 135W  
 ■ FLASH

GX251LW - BUBBLE  
 ◆ 2,5 m ◆ 5 m ▣ 2,5 m ▲ 245 kg ↻ 135W  
 ■ FLASH

TO ORDER

TO ORDER

TO ORDER

TO ORDER

TO ORDER



SV301/SV501/SV1001



SV801W-P/SV1201W-P



SND022



SND019



SV507W



DECORATIONS  
SOLD SEPARATELY

DECORATIONS  
SOLD SEPARATELY

DESCRIPTION	HEIGHT	DIAMETER	VOLTAGE (W)	NBR OF LIGHTS POINTS	WEIGHT	NBR OF ELEMENTS	●	●
CONICAL FIR TREE	3 m	1,18 m	24W	612 + 156 flashes	49 kg	3	SV301	SV301W
CONICAL FIR TREE	5 m	1,80 m	64W	1028 + 364 flashes	241 kg	7	SV501	SV501W
CONICAL FIR TREE	10 m	3,43 m	252W	6528 + 1664 flashes	985 kg	23	SV1001	SV1001W
CONICAL CROSSING FIR TREE	8 m	2,78 m	200W	4284 + 1092 flashes	585 kg	17	SV801-P	SV801W-P
CONICAL CROSSING FIR TREE	12 m	4,08 m	420W	10148 + 2587 flashes	1174 kg	39	SV1201-P	SV1201W-P

TO ORDER

SND022 - ROMANTIC

◆ 2,7 m ◆ 8 m ■ 2,7 m 🏠 315 kg ⚡ 300W

● STARS-COMETE-FLASH

TO ORDER

SND019 - GRAND VEGA GREEN

◆ 2,2 m ◆ 6,25 m ■ 2,2 m 🏠 170 kg ⚡ 275W

● STARS-XLED

TO ORDER

SV507W - ALPS TREE

◆ 1,8 m ◆ 5,4 m ■ 1,8 m 🏠 125 kg ⚡ 200W

● FLASH

TO ORDER



SND021

SV504A

SL041W

SND018

GP158WF

GP1-400

GP1-600

5,5 m

3,12 m

3 m

2,7 m

3 m

4 m

6 m

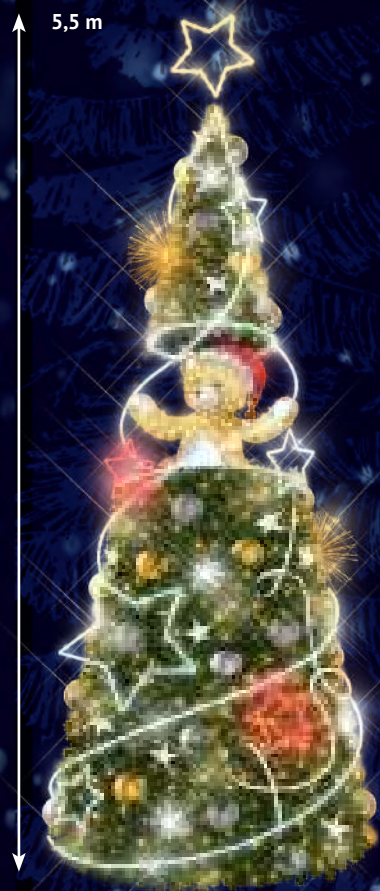

SND021 - TEDDY

◆ 2,5 m ◆ 5,5 m ▫ 2,5 m ▲ 172 kg ↻ 325W  
● FLASH

TO ORDER

SV504A - DAVE A

◆ 1,6 m ◆ 3,12 m ▫ 1,6 m ▲ 44,5 kg ↻ 35W  
● FLASH

SL041W - NORDIKA 3D - ECO

◆ 2,4 m ◆ 3 m ▫ 2,4 m ▲ 72 kg ↻ 125W  
● SLOWGLOW

SND018 - VEGA GREEN

◆ 0,88 m ◆ 2,7 m ▫ 0,88 m ▲ 25,5 kg ↻ 30W  
● FLASH

GP158WF - SAPIN VERT PRÉ ILLUMINÉ

◆ 1,35 m ◆ 2,1 m ▫ 1,35 m ▲ 18 kg ↻ 25W  
● STARS/FLASH

GP1-400 - SAPIN VERT PRÉ ILLUMINÉ

◆ 4 m ▫ 2,20 m ▲ ↻ 87 W  
● FLASH

NEW

GP1-600 - SAPIN VERT PRÉ ILLUMINÉ

◆ 6 m ▫ 3,20 m ▲ ↻ 87W  
● FLASH

NEW







# NORDIKA

*the Christmas tradition*

The perfect regularity of the branches, the realistic high-quality finishes and a majestic size make our conifers a festive must. You can customise your Nordika every year for a unique look: hang Christmas baubles on its branches, add a set of lights, or even set it on a wooden base.

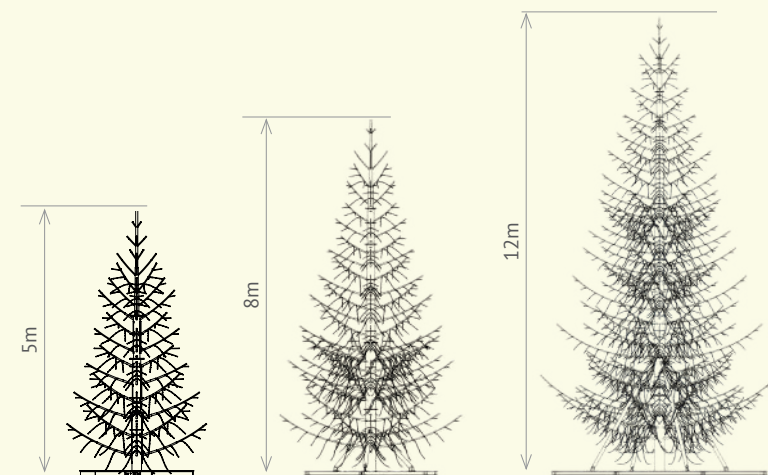

NAME	Ø	◆	⚡	👤	FLASHS	LED	NBR OF ELEMENTS	REFERENCES
Sapin Nordika - PM	3,56 m	5 m	245 W	263 kg	☀️	2 976 (1 488 steady + 1 488 with slowglow effect)	46	GX081LW-2
Sapin Nordika - MM	4,70 m	8 m	770 W	1 112 kg	☀️	8 664 (4 332 steady + 4 332 with slowglow effect)	107	GX082LW
Sapin Nordika - GM	5,90 m	12 m	1 870 W	2 750 kg	☀️	21 048 (10 524 steady + 10 524 with slowglow effect)	194	GX083LW

## CELEBRATING 10 YEARS

To mark its tenth anniversary, our Christmas tree has undergone a transformation: a redesigned branch structure for a more harmonious silhouette, a deeper green hue, and an even more realistic look. An evolution born from our constant drive to innovate, offering an even more magical, fuller, and more radiant tree than ever before.

## FREE STANDING NO NEED TO SECURE WITH WIRES

The Nordika is built on a robust internal framework that ensures its stability without the need for external cables or wires for balance.

## TOTALLY SAFE 24V

100% secure thanks to its 24V voltage across the entire tree.

## INDOOR & OUTDOOR USE

Thanks to its weather-resistant structure and durable materials, it withstands outdoor conditions perfectly while remaining elegant and safe indoors.

## PVC FREE

The recyclable polyethylene branches provide a natural appearance and an eco-friendly approach. This innovative material perfectly mimics the look of real branches while being durable and environmentally friendly.

## PRE-LIGHTED WITH 100% LED SLOWGLOW EFFECT

No need to install string lights anymore: the tree comes pre-decorated and ready to shine.

## CAN BE TOTALLY DISMANTLED

Transport and storage are also made easier.





# ACCESSORIES

for *NORDIKA*

## DECORATIVE BAUBLES KIT

Each kit features 52 baubles in the same colour (M1/B1 category-fireproof)  
- 50% shiny /50% satiny

- 28 baubles ø 12 cm
- 20 baubles ø 20 cm
- 4 baubles ø 25 cm

COLOUR	REFERENCE
Silver	KITNDK-A
Blue	KITNDK-B
Gold	KITNDK-O
Red	KITNDK-R

**NORDIKA - 5 M = 2 kits - 104 baubles**  
**NORDIKA - 8 M = 4 kits - 208 baubles**  
**NORDIKA - 12 M = 8 kits - 416 baubles**

## BIOPRINT & RECYPRINT KIT

Each kit features 20 motives

- 8 motives ø 50 cm
- 12 motives ø 30 cm

REFERENCE	TYPE	COLOUR
KITNDK-F	Snowflake	Blue
		White
KITNDK-E	Star	Gold
		White

**NORDIKA - 5 M = 2 kits - 40 decorations**  
**NORDIKA - 8 M = 4 kits - 80 decorations**  
**NORDIKA - 12 M = 8 kits - 160 decorations**



## TREE TOPPER

These carefully designed toppers allow you to customise the top of your tree, giving it a unique and magical finish.



DESIGNATION	◆	REFERENCE
Cimier BELLA	1 m	CIME2
Cimier AIGUILLE	1 m	CIME4
Cimier MIA	1 m	CIME6
Cimier STAR7	0,80 m	CIME7

## BASE

Stabilise and enhance your Nordika tree with our specially designed bases!



**NORDIKA - 5 M = SOCLGX81**  
**NORDIKA - 8 M = SOCLGX82**  
**NORDIKA - 12 M = SOCLGX83**

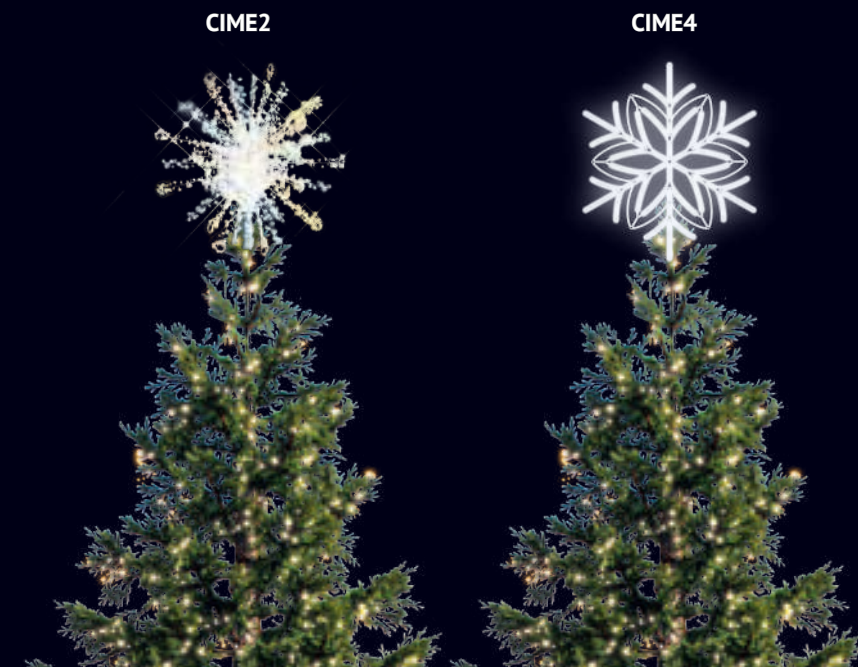



# SUSPENSIONS

*collections*

# ARTY

The ARTY collection is inspired by the refinement and purity of the Art Deco artistic movement. We have elegantly mixed the geometric lines of this timeless artistic style with the traditional symbols of Christmas. Flashes, diamond shapes and streamlined curves are accented with light, enabling us to create an extremely elegant and dynamic decoration that is equally beautiful day and night in your streets.

- ART DECO
- REFINEMENT
- GEOMETRIC SHAPES
- ELEGANCE
- FLASH OF LIGHT
- DROP BEADS

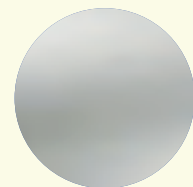
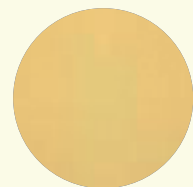
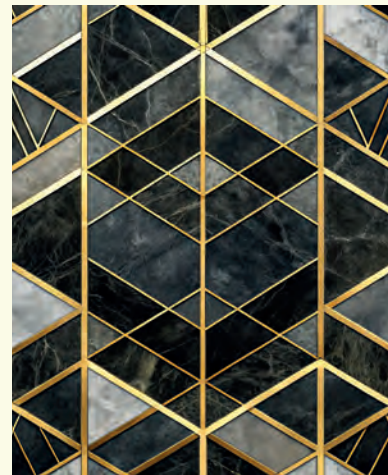
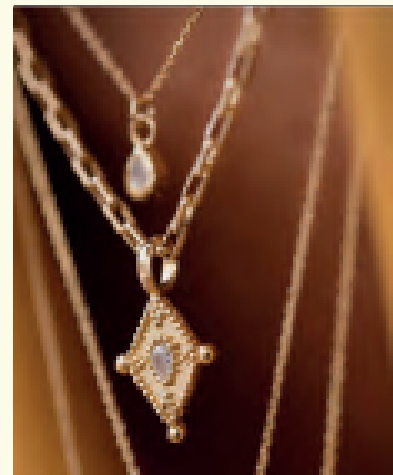

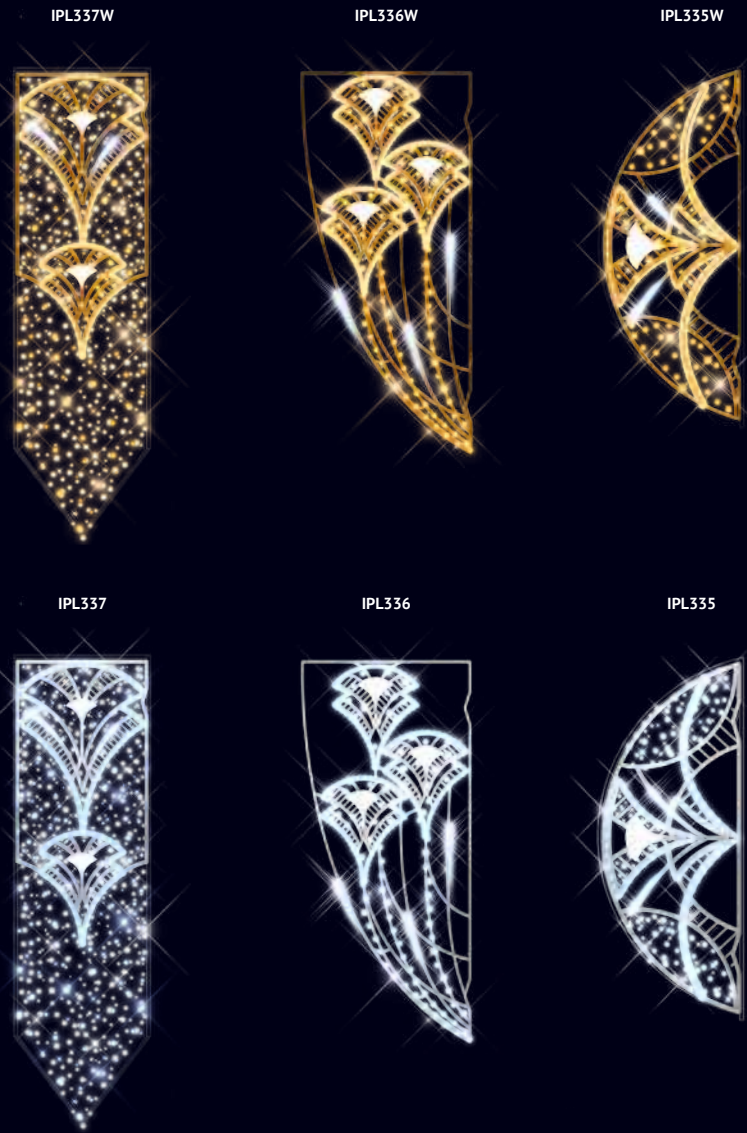

IPL337W - GATSBY BANNER  
 ◆ 0,8 m ◆ 2,8 m ◆ 6,9 kg ⚡ 40W  
 SLOWFLASH-SOFT XLED 52

IPL336W - GATSBY GRAND  
 ◆ 0,9 m ◆ 2 m ◆ 6,6 kg ⚡ 45W  
 SLOWFLASH-SOFT XLED 79

IPL335W - GATSBY  
 ◆ 0,6 m ◆ 1,5 m ◆ 3,8 kg ⚡ 30W  
 SLOWFLASH-SOFT XLED 37

ITL338W - GATSBY UNIT  
 ◆ 0,75 m ◆ 1 m ◆ 3,1 kg ⚡ 25W  
 SLOWFLASH-SOFT XLED 29

IPL337 - GATSBY BANNER  
 ◆ 0,8 m ◆ 2,8 m ◆ 6,9 kg ⚡ 40W  
 SLOWFLASH-SOFT XLED 52

IPL336 - GATSBY GRAND  
 ◆ 0,9 m ◆ 2 m ◆ 6,6 kg ⚡ 45W  
 SLOWFLASH-SOFT XLED 79

IPL335 - GATSBY  
 ◆ 0,6 m ◆ 1,5 m ◆ 3,8 kg ⚡ 30W  
 SLOWFLASH-SOFT XLED 37

ITL338 - GATSBY UNIT  
 ◆ 0,75 m ◆ 1 m ◆ 3,1 kg ⚡ 25W  
 SLOWFLASH-SOFT XLED 29









ITL101W



ITL101

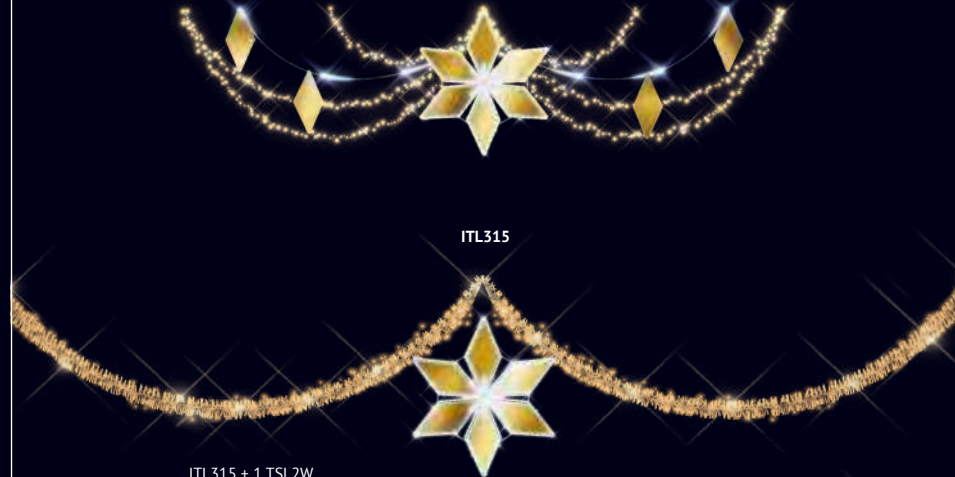

ITL316W

ITL315



ITL102W



PIX05B

ITL020W

ITL315 + 1 TSL2W



ITL163



ITL233

<b>ITL101W - GRAND MIA</b>	
◆ 2 m ◆ 2 m	▲ 18 kg ↻ 150W
● SLOWFLASH-STARS-XLED	📏 216

<b>ITL102W - MIA</b>	
◆ 1 m ◆ 1 m	▲ 5,8 kg ↻ 45W
● SLOWFLASH	📏 73

<b>PIX05B - XMAS PIX</b>	
◆ 0,9 m ◆ 0,85 m	▲ 2 kg ↻
NEW	📏

<b>ITL316W - HEXA CHAIN</b>	
◆ 4 m ◆ 1 m	▲ 13 kg ↻ 80W
● FLASH-SOFT XLED	📏

<b>ITL163 - THORN CHAIN</b>	
◆ 6 m ◆ 1,24 m	▲ 26,5 kg ↻ 115W
● SLOWFLASH	📏 194

<b>ITL101 - GRAND MIA</b>	
◆ 2 m ◆ 2 m	▲ 18 kg ↻ 150W
● SLOWFLASH	📏 216

<b>ITL020W - GIVRE</b>	
◆ 0,85 m ◆ 0,97 m	▲ 4,5 kg ↻ 40W
● FLASH	📏 47

<b>ITL315 - HEXA</b>	
◆ 0,85 m ◆ 0,95 m	▲ 2,3 kg ↻ 20W
● SLOWFLASH	📏

<b>ITL233 - QUADRILLE JF</b>	
◆ 4,5 m ◆ 0,8 m	▲ 15,1 kg ↻ 105W
● XLED-FLASH-STARS	📏 166



ITL101W + GP503W



# Grace

The GRACE collection is inspired by Baroque style. Born in Italy in the 17th century, this artistic movement is characterised by its majestic ornamentation and arabesques, symbols that we have chosen to combine with more pared-back contemporary lines. An essential element in Baroque style, the chandelier is available in several versions that you will find in these pages.

- BAROQUE
- ARABESQUES
- CHANDELIERS
- ELEGANCE
- ORNAMENTATION
- GILDING

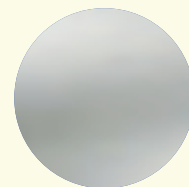
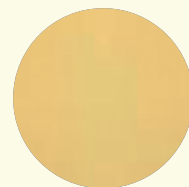

































2D

ITL053



ITL053W



3D

ITGL104



ITGL104W

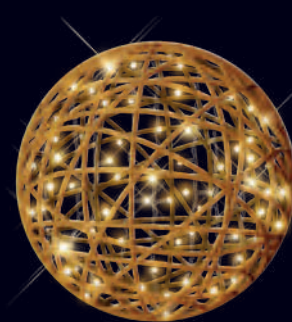

ITGL105



ITGL105W

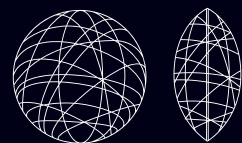
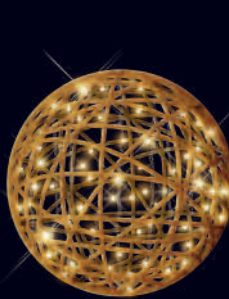

Vue de face    Vue de côté

ITL053 - SPHERE GM					
◆ 1 m	◆ 1 m	■	▲ 2,8 kg	⚡ 20W	
●	●	●			🕒 35
FLASH					

ITL053W - SPHERE GM					
◆ 1 m	◆ 1 m	■	▲ 2,8 kg	⚡ 20W	
●	●	●			🕒 35
SLOWFLASH					

ITGL104 - SPHERE FULL MM					
◆ 0,5 m	◆ 0,5 m	■ 0,26 m	▲ 1,7 kg	⚡ 10W	
●	●	●			🕒
SLOWFLASH					

ITGL104W - SPHERE FULL MM					
◆ 0,5 m	◆ 0,5 m	■ 0,26 m	▲ 1,7 kg	⚡ 10W	
●	●	●			🕒
SLOWFLASH					

ITGL105 - SPHERE FULL GM					
◆ 0,8 m	◆ 0,8 m	■ 0,4 m	▲ 3,2 kg	⚡ 20W	
●	●	●			🕒
SLOWFLASH					

ITGL105W - SPHERE FULL GM					
◆ 0,8 m	◆ 0,8 m	■ 0,4 m	▲ 3,2 kg	⚡ 20W	
●	●	●			🕒
SLOWFLASH					



3D

TGL70LW

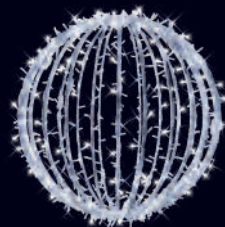

TGL71LW

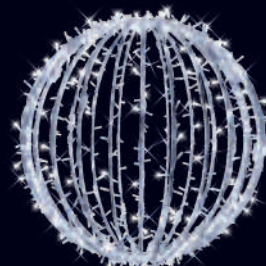

TGL72LW

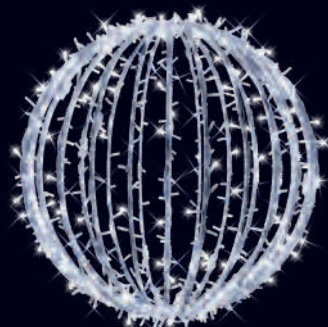

TGL71LWCL

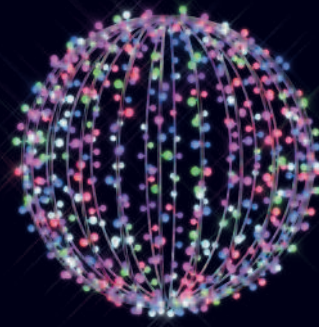

TGL70LWW

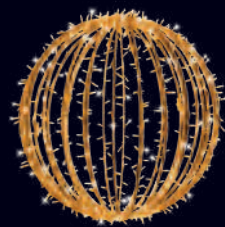

TGL71LWW

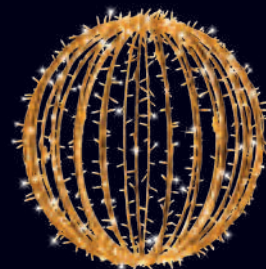

TGL72LWW

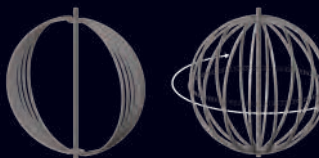

<b>TGL70LW - SPHERE PLIABLE PM</b>					
◆ 0,6 m	◆ 0,6 m	■ 0,6 m	▲ 3,9 kg	↙ 30W	
■	■	■	■	■	FLASH

<b>TGL70LWW - SPHERE PLIABLE PM</b>					
◆ 0,6 m	◆ 0,6 m	■ 0,6 m	▲ 3,9 kg	↙ 30W	
■	■	■	■	■	FLASH

<b>TGL71LW - SPHERE PLIABLE MM</b>					
◆ 1 m	◆ 1 m	■ 1 m	▲ 11,5 kg	↙ 75W	
■	■	■	■	■	FLASH

<b>TGL71LWW - SPHERE PLIABLE MM</b>					
◆ 1 m	◆ 1 m	■ 1 m	▲ 11,5 kg	↙ 75W	
■	■	■	■	■	FLASH

<b>TGL72LW - SPHERE PLIABLE GM</b>					
◆ 1,6 m	◆ 1,6 m	■ 1,6 m	▲ 24,8 kg	↙ 165W	
■	■	■	■	■	FLASH

<b>TGL72LWW - SPHERE PLIABLE GM</b>					
◆ 1,6 m	◆ 1,6 m	■ 1,6 m	▲ 24,8 kg	↙ 165W	
■	■	■	■	■	FLASH

<b>TGL71LWCL - CHERRY LIGHT SPHERE</b>					
◆ 1 m	◆ 1 m	■ 1 m	▲ 11,5 kg	↙ 15W	
■	■	■	■	■	FLASH





ITGL141



ITGL131



ITGL111



ITGL117R



ITGL131W



ITGL111W

ITGL141 - ALTO					
◆ 1 m	◆ 1 m	■ 0,4 m	▲ 5,1 kg	⚡ 35W	
●	●				ⓘ

ITGL117R - LOVE					
◆ 0,6 m	◆ 0,6 m	■ 0,46 m	▲ 2 kg	⚡ 8W	
■	●				ⓘ

ITGL131 - GOUTTE					
◆ 0,4 m	◆ 0,8 m	■ 0,26 m	▲ 1,8 kg	⚡ 10W	
●	●				ⓘ

ITGL131W - GOUTTE					
◆ 0,4 m	◆ 0,8 m	■ 0,26 m	▲ 1,8 kg	⚡ 10W	
■	●				ⓘ

ITGL111 - STAR 7					
◆ 0,8 m	◆ 0,8 m	■ 0,18 m	▲ 1,9 kg	⚡ 15W	
●	●				ⓘ

ITGL111W - STAR 7					
◆ 0,8 m	◆ 0,8 m	■ 0,18 m	▲ 1,9 kg	⚡ 15W	
■	●				ⓘ



ITGL111 + ITGL112

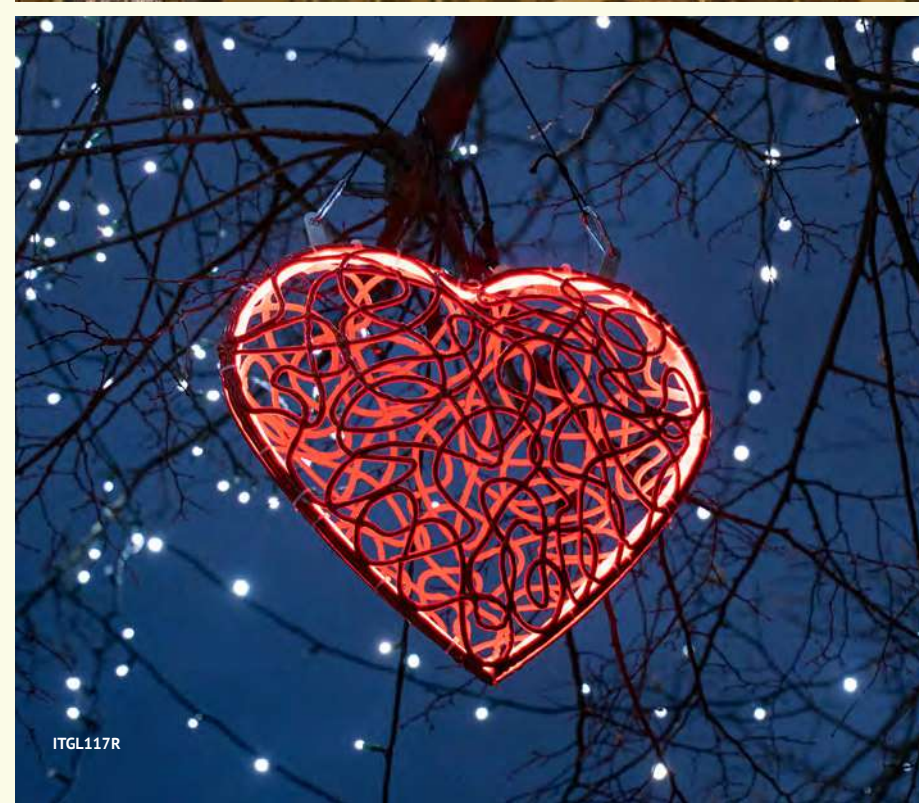

ITGL117R



ITGL141





GX117LW



GX048LW



TGL247LW



GX116LW

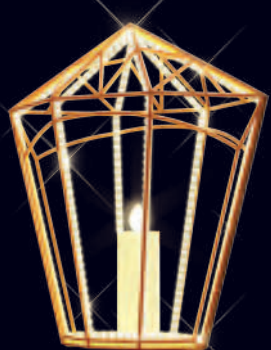

ITGL130W



TL347W  
2D

**GX117LW - ULYSSE**  
 ◆ 1,5 m ◆ 2 m ■ 1,5 m ▲ 25,6 kg ↻ 130W  
 ■ FLASH ⚡ 11

**GX116LW - ACHILLE**  
 ◆ 0,6 m ◆ 0,7 m ■ 3,6 kg ↻ 15W  
 ●

**GX048LW - AURORA**  
 ◆ 0,48 m ◆ 0,73 m ■ 0,48 m ▲ 4,3 kg ↻ 40W  
 ●

**ITGL130W - LANTERNA**  
 ◆ 0,7 m ◆ 0,8 m ■ 0,4 m ▲ 2,9 kg ↻ 25W  
 ■ ●

**TGL247LW - LUZ**  
 ◆ 0,26 m ◆ 0,36 m ■ 0,26 m ▲ 1,3 kg ↻ 5W  
 ●

**TL347W - LANTERN**  
 ◆ 0,8 m ◆ 1 m ■ 2,8 kg ↻ 20W  
 ● ● STARS



GX116LW + GP138L



ITGL130W

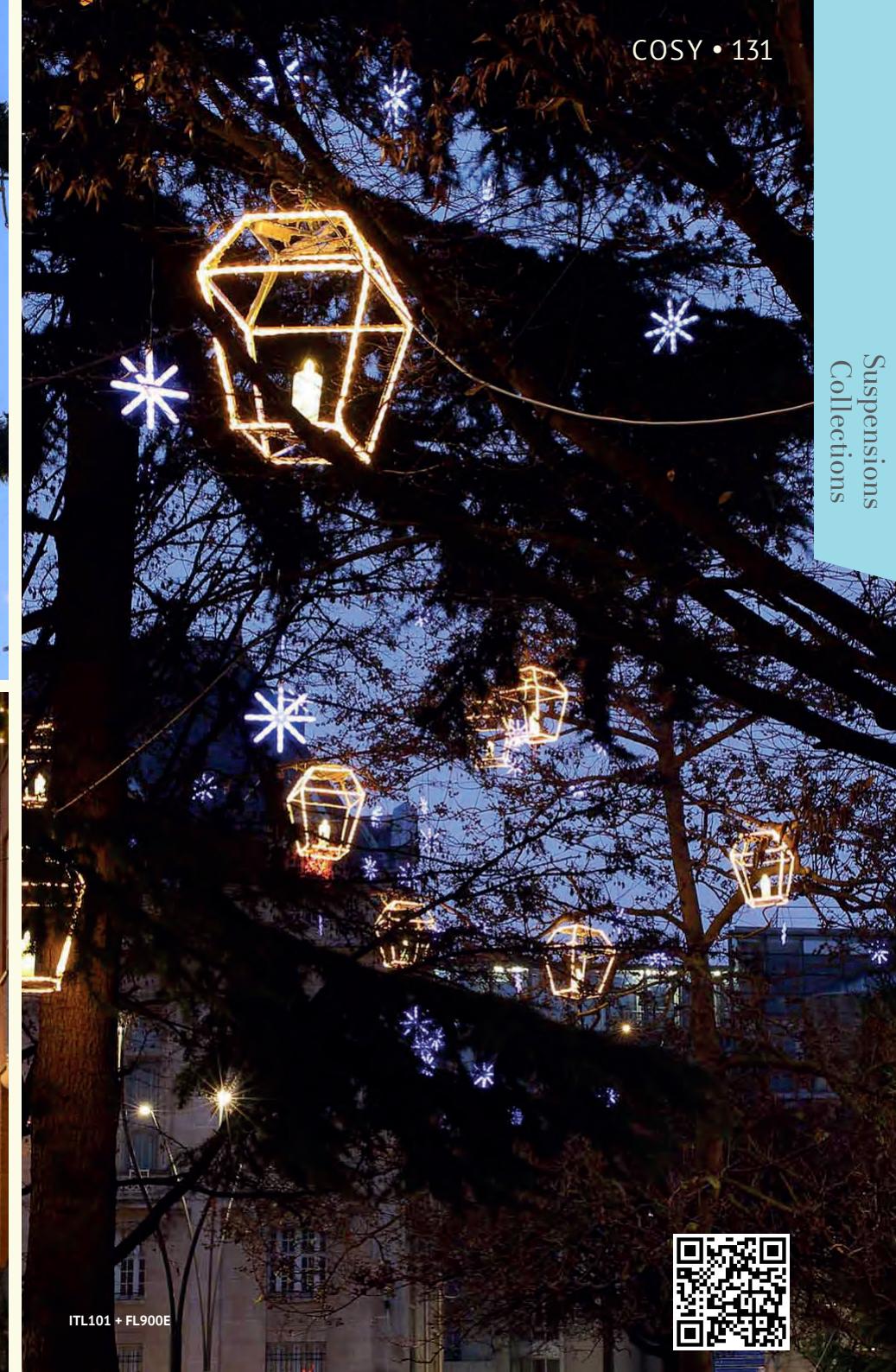

ITL101 + FL900E



# Cristal

The Cristal collection brings a breath of freshness to your polar decoration. Delicate arabesques and more decorative lines warm up this glacial world. New snowflakes with softer designs in warm shades, mixing pure white and warm white, make up this range inspired by the nomadic peoples of the Far North.

- POLAR
- MOUNTAINS
- FROSTY ATMOSPHERE
- SNOWFLAKES
- BLIZZARD
- ARCTIC

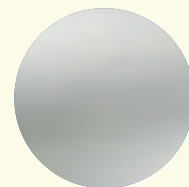
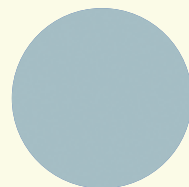
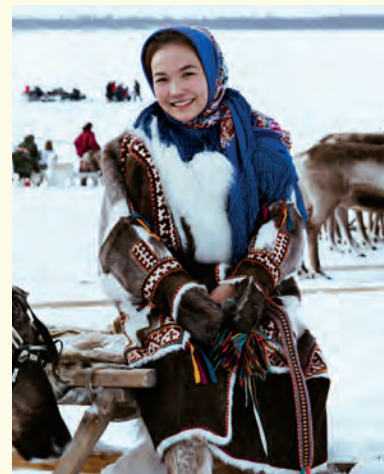
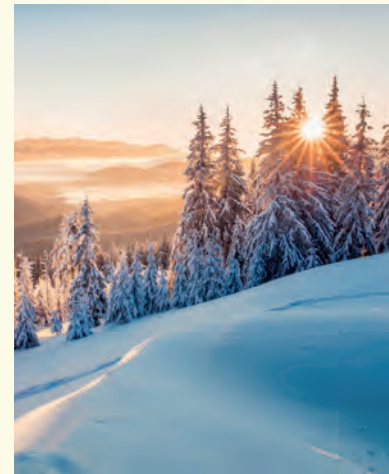

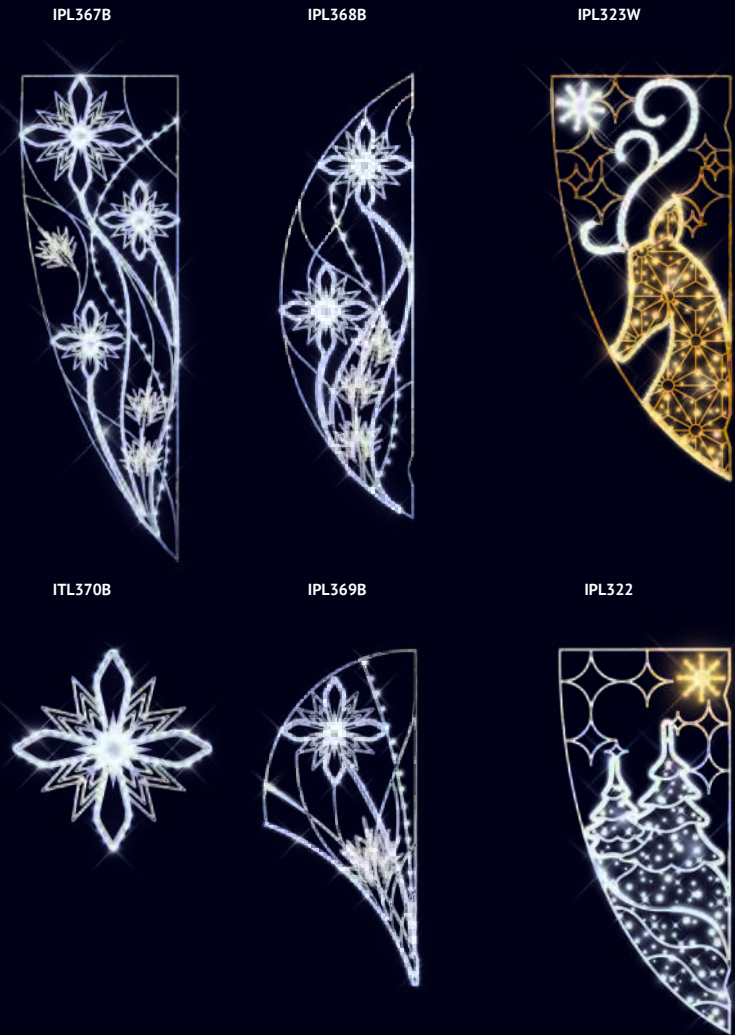

<b>IPL367B - EDELWEISS GRAND</b>				
◆ 1 m	◆ 3 m	■	▲ 12 kg	↺ 83W
●	●			STARS
			⌋ 131	

**NEW**

<b>ITL370B - EDELWEISS UNIT</b>				
◆ 0,75 m	◆ 0,75 m	■	▲ 3 kg	↺ 15W
●	●			STARS
			⌋ 31	

**NEW**

<b>IPL368B - EDELWEISS</b>				
◆ 0,7 m	◆ 2,3 m	■	▲ 8 kg	↺ 50W
●	●			STARS
			⌋ 75	

**NEW**

<b>IPL369B - EDELWEISS PETIT</b>				
◆ 0,7 m	◆ 1,5 m	■	▲ 5 kg	↺ 32W
●	●			XLED-STARS
			⌋ 48	

**NEW**

<b>IPL323W - JOEL</b>				
◆ 0,9 m	◆ 2 m	■	▲ 5,6 kg	↺ 35W
●	●	●		FLASH
			⌋ 67	

**NEW**

<b>IPL322 - WOODY</b>				
◆ 0,9 m	◆ 2 m	■	▲ 5,4 kg	↺ 25W
●	●			FLASH
			⌋ 52	

**NEW**



<b>ITL368B - EDELWEISS DOUBLE</b>				
◆ 4,6 m	◆ 0,7 m	■	▲ 16 kg	↺ 100W
●	●			STARS
			⌋ 150	

**NEW**

<b>ITL371B - EDELWEISS CURVE</b>				
◆ 5 m	◆ 1,1 m	■	▲ 20 kg	↺ 117W
●	●			STARS-FLASHY
			⌋ 190	

**NEW**

<b>ITL232W - LINE JF</b>				
◆ 4 m	◆ 1 m	■	▲ 17 kg	↺ 120W
●	●			XLED-STARS
			⌋ 83	

**NEW**

























# SOLAR RANGE

*varied and adaptable decorations work with solar energy*

Thanks to our new solar-powered rechargeable battery, you can combine lighting with energy efficiency.

Once your decor is in place, position the solar box on top of it facing the right way, set your switch-on and switch-off times and enjoy your lighted decorations.

Technical details:

- 8 to 10 hours of recharging with optimal sunlight for 7 hours of lighting.
- your lights can be programmed to operate for 5, 6 or 7 hours.

## PIXSOL2

20W pannel power  
7,2W power output

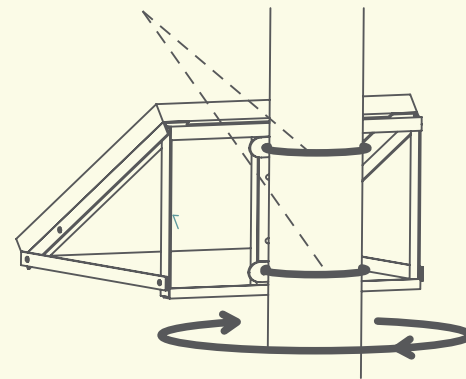

When you set it up, make sure it is facing the right way to get the most sun during the day. These decorations are equipped only with 24V LED string lights.

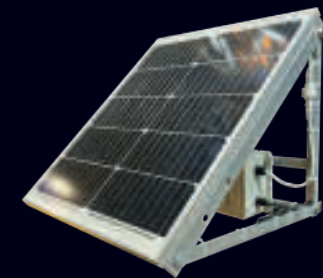

PIXSOL2 (p.275)



IPS289W

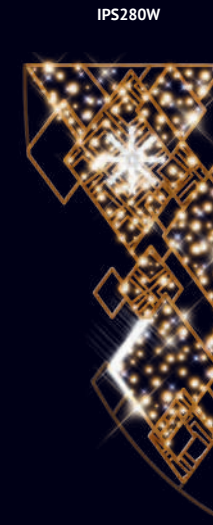

IPS280W



IPS280

IPS290



IPS264W



IPS281W



IPS289W - STARS S.				
◆ 0,6 m	◆ 1,2 m	■	▲ 2,5 kg	↺ 5W
●	●	●	●	●
FLASH-STARS				
				● 30

IPS280W - QUADRILLE S.				
◆ 0,9 m	◆ 2 m	■	▲ 6 kg	↺ 10W
●	●	●	●	●
FLASH-XLED-STARS				
				● 57

IPS280 - QUADRILLE S.				
◆ 0,9 m	◆ 2 m	■	▲ 6 kg	↺ 10W
●	●	●	●	●
FLASH-XLED-STARS				
				● 57

IPS290 - RIBBON S.				
◆ 0,43 m	◆ 1,8 m	■	▲ 3,4 kg	↺ 10W
●	●	●	●	●
FLASH-XLED				
				● 32

IPS264W - BLIZZY S.				
◆ 0,5 m	◆ 1,2 m	■	▲ 2 kg	↺ 5W
●	●	●	●	●
FLASH-STARS				
				● 28

IPS281W - RIBBON S.				
◆ 0,6 m	◆ 1,2 m	■	▲ 2,5 kg	↺ 5W
●	●	●	●	●
FLASH-XLED				
				● 28











# STRING LIGHTS

*& luminous curtains*

SPARKLIGHT® EUROPA STRING LIGHTS 168 – 169

MULTICOLOURED RGBWW/RGB 170 – 173

STRING LIGHTS RANGE 174 – 197

LED CURTAINS 198 – 217

LED STALACTITES 218 – 231

CEILINGS AND BRAIDS 232 – 245

SUSPENSIONS AND DECORATIONS 246 – 266

PROJECTORS 267 – 270

# CONTENTS



## Legends

- |                  |  |
|------------------|--|
| ◆ Height         | ✓ Indoor/outdoor use                         |
| ◀ Length         | □ PVC Type of cable                          |
| ▀ Depth          | IP24 Protection class                        |
| ⚡ Voltage        | incl. Power cord supplied                    |
| ▮ Nb of runs     | IK08 Impact rating                           |
| 🔌 Nb connectable | ☠ Exclusive Octoplus by blachere® 230V range |
| ☀ Flash color    | ☠ Exclusive Octoplus by blachere® 24V range  |
| ● LED color      | ☠ Exclusive Octoplus by blachere® 12V range  |
| ■ Cable color    |  |
| N New            |  |

# BLACHERE LEDs

The different types of Blachere® LEDs :

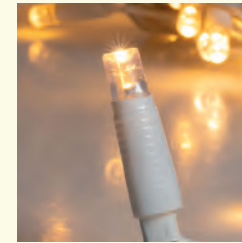

**LED +**  
An exclusive 100% Blachere® innovation



**SPARKLIGHT EUROPA LED**  
A unique, instantly recognizable star shape.

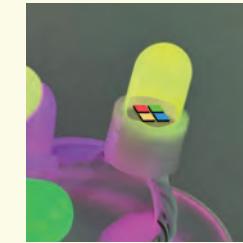

**LED RGBWW/RGB**  
A special capsule for better color diffusion.

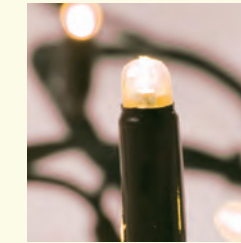

**LED CLASSIQUE**  
A robust and stable encapsulated LED with an inverted interior cone.

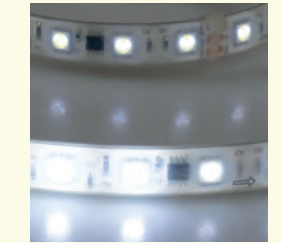

**LED SMD**  
The ultimate electrical component, manufactured by an automatic machine.



**LED + :**  
By approaching innovation through usage, our R&D department has developed the brand new Led+ in fixed and slow flash versions to make your projects sparkle! The result of a long-standing collaboration with Nichia®, the world leader in LEDs, we are delighted to offer you an exclusive new range:

**brighter, more robust, longer lifespan, more consistent colour quality**

The new technical features of Led+ are:

- > **Optimised and patented design** to enhance the luminous efficiency of our solutions (Reverse conical principle).
- > **Maximised heat dissipation** for increased service life.
- > **Uniform phosphorus deposition** for uniform light output.
- > **2-year guarantee.**
- > **Optimal protection rating: IP66/IP69.**
- > **Octoplus 230V connector by Blachere IP67.**
- > **Optimized energy performance: a 15% reduction in consumption.**

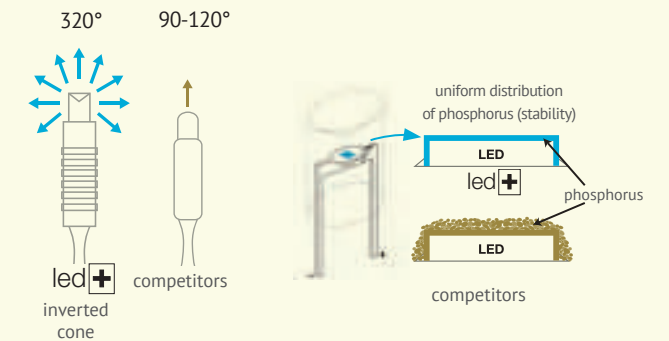

# SPARKLIGHT® EUROPA

by Blachere Illumination



Ten years after revolutionising our industry with large-format 3D printing, we have met a new challenge: manufacturing competitive, high-quality made in France string light.

We are proud to present SPARKLIGHT® EUROPA, designed and manufactured in our workshops in Provence, France.

SPARKLIGHT® EUROPA is the culmination of several years' Research and Development and investment, combined with unique know-how developed and

kept alive on French soil for more than half a century, which has earned the company the EPV Living Heritage Company Label, awarded several years ago.

The launch of our French string lights embodies our continuously renewed commitment to responsible innovation, combining industrial expertise, creativity and energy efficiency to create the magic of Christmas and meet the concrete needs of municipalities.



## FRENCH KNOW-HOW

SPARKLIGHT® EUROPA is produced in our workshops in Apt, where Blachere was founded over 50 years ago. Our unique know-how is a perfect balance between traditional craftsmanship and industrial efficiency.

## LOCAL ECONOMY

Supporting European production reinforces our industrial autonomy and strengthens employment in Europe. Local production is a reliable alternative to import disruptions.

## SHORT SUPPLY CHAIN

All stages of production and packaging take place in our workshops in Apt, France, significantly reducing intercontinental transport.



# SPARKLIGHT® EUROPA

by Blachere Illumination



## VERSION N°1

◀	LED	⚡	🔌	□
8 m	80 ●	3	x	F080W-B FY09-B
Rectified power cable only for F080W-B				
<b>Sparklight Europa mounting option in light curtain configuration :</b>				
15-drop collector for creating a light curtain				FY025-B
Power cable 230V Octopus				FY08-B+
Bridge rectifier 1A/230V Octopus				FY041-AB+

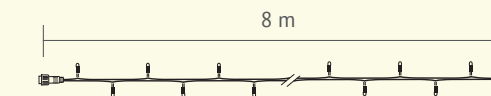

## VERSION N°2

◀	LED	⚡	🔌	■	□
16 m	160 ●	3	6	F160	F160-B
16 m	160 ●	3	6	F160W	F160W-B
◀	DESIGNATION	⚡	■	□	
1,50 m	power cable		FY08+	FY08-B+	
0,30 m	bridge rectifier	690W max	FY043A+	FY043A-B+	
0,20 m	bridge rectifier	230W max	FY041A+	FY041A-B+	

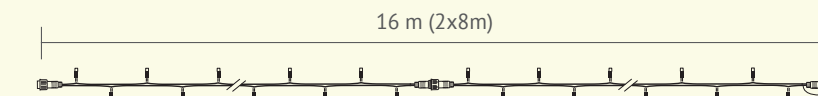

## PRODUCT INFO

### BLACHERE ILLUMINATION INNOVATION

Our new SPARKLIGHT® EUROPA string light is produced and packaged in France. Equipped with energy-efficient LEDs - like all our string lights - SPARKLIGHT® EUROPA consumes only 3W for 80 LEDs, making it the most eco-friendly string light in our range. Our new string light is a robust innovation, designed for outdoor and professional use only. Compatible with the Octopus system by Blachere, it can be configured into a stunning tree curtain.





# STRING LIGHTS iLED ColorTech by Blachere®

## RGBWW - multicoloured

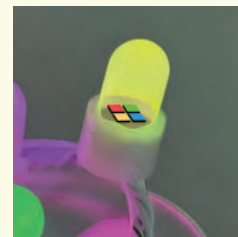

4-colour +LED

### RGBWW

	RGBWW	⚡	⏏	■	□
13 m		32	x	FT-ST128	FT-ST128B
2 x 6,5 m		32	x	FT-ST64	

### ACCESSORIES REQUIRED FOR THESE REFERENCES

DESIGNATIONS	⚡	□
transformer amplifier 12V/50W	50W	FT-TRAS50
animator / transformer 12V/50W	50W	FT-TRC50

### PRODUCT DETAILS

**iLED Colour Tech Innovation by Blachere®**  
 A product developed exclusively for the Champs-Élysées, now available to all our clients.  
 Recreate the world's most beautiful avenue in your own town!  
 - New LED shape  
 - Brighter (WW 10 lumens/pixel)

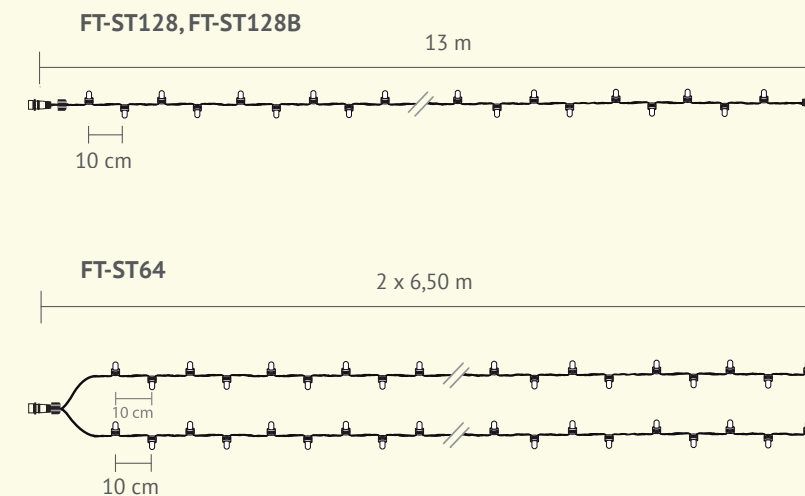
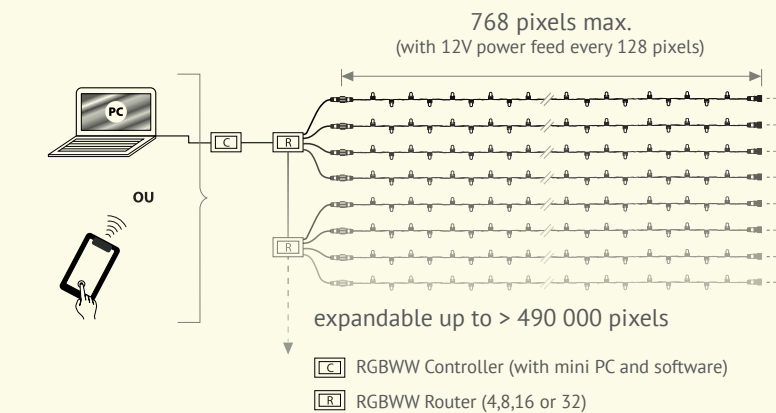

- Unique colours and shades (warm white 2300/2500K)
- Up to 6 string lights end-to-end (768 linear pixels – 78 m) > 490,000 pixels
- Open DMX-compatible software, professional and intelligent (multilingual)
- Free addressing
- Reinforced durability with nylon cable















# TREE LIGHT HP KIT

*statics*



## STATICS

	<b>LED</b>			
50 m	400	72	25 m max.	416WHP



## ACCESSORIES INCLUDED WITH THIS REFERENCE

<b>DESIGNATION</b>	
2 x 24V/72W transformers	72W
5 x 24V female connector cables	24V
10 heat-shrink connectors + 5 heat-shrink sleeves + 5 end caps	

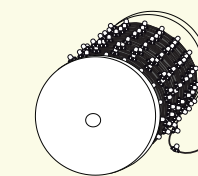

## PRODUCT DETAILS

A classic for traditional street decorations. Quick-connect accessories, extension cables, multi-socket connectors, Octopus 230V by Blachere®.



# LEDMOSPHERE STRING LIGHTS

*flash or statics*



micro steel wire

## FLASH

◆	◆		FLASH	⚡	🔌	🔌	■
10 m	x		30 30	8	x	10	600WWF

## STATICS

◆	◆	LED	FLASH	⚡	🔌	🔌	■
10 m	x	30	x	14	x	10	600W
50 m	x	150	x	70	x	2	650W

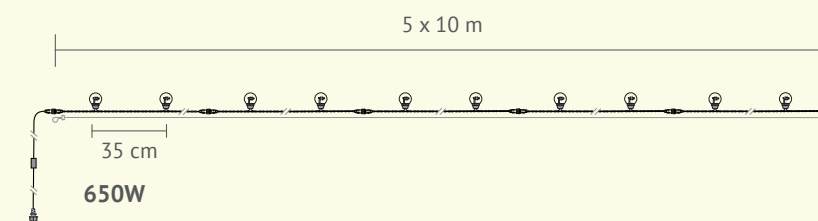
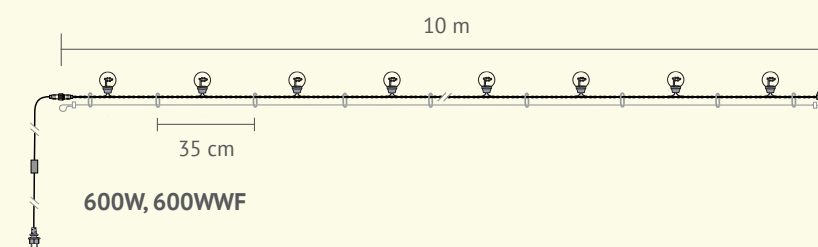

## PRODUCT DETAILS

String lights packaged in rolls and mounted on a steel wire which will allow an easy installation and a greater resistance. Compatible with the Octoplus 230V range. Carabiners supplied.





série LDL B22/E27 (modèle déposé)



série LDLH B22 SMD



LDLFL-B22







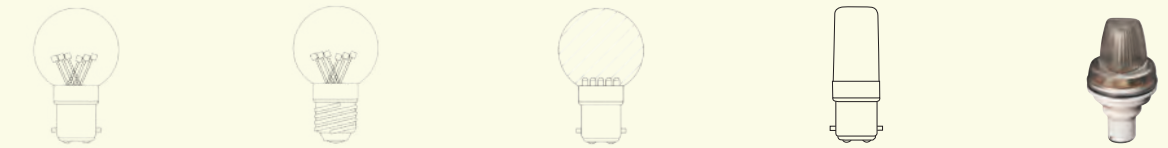

F722-L / F732-L



## B22/E27 BULBS & STARFLASH®



DESCRIPTION	B22	E27	B22	B22	B22 FLASH	
TYPE OF GLOBE	polycarbonate	polycarbonate	polycarbonate	polycarbonate	polycarbonate	
Ø OF GLOBE	45 mm	45 mm	45 mm	36 x 115 mm		
VOLTAGE	230V	230V	230V	230V	230V	
INTENSITY	3,68VA	3,68VA	3,68VA		0,5J	2J
WATTAGE	16mA max/ 0,5W	16mA max/ 0,5W	16mA max/ 0,5W	3W	1W	1W
PACKING	set of 25	set of 25	set of 25	unit	unit	unit
	LDL11-B2	LDL11-E2	LDLH11		F722-L	F732-L
	LDL11W-B22	LDL11W-E27	LDLH11W			
	LDL12-B22	LDL12-E27	LDLH12	LDLFL-B22		
	LDL13-B22	LDL13-E27	LDLH13			
	LDL14-B22	LDL14-E27	LDLH14			
	LDL16-B22	LDL16-E27	LDLH16			
	LDL18-B22	-	LDLH18			

**Low power consumption bulb - Note :** use the appropriate power (16mA i.e 3,68VA) to calculate the rating of your network (cable section area, circuit breaker, power required etc.). Use 0,5W per bulb to calculate the power consumption. In outdoor use, must be mounted on garland with B22 sockets minimum IPX4 with waterproof seal fitted.

### PRODUCT DETAILS

The LDL series is a classic of Blachere lighting. A registered model, the particular arrangement of the LEDs in the bulb globe gives a «filament effect» similar to the incandescent bulbs of yesteryear. The polycarbonate globe guarantees an increased solidity (IK06). The LDLFL-B22 recreates the effect of a flame, regardless of the mounting direction. F722-L / F732-L. A historical product that is easy to use on a B22 lampholder. Produces 1 flash approximately every 3 seconds.

# CHERRYLIGHT® STRING LIGHT

*multicoloured*

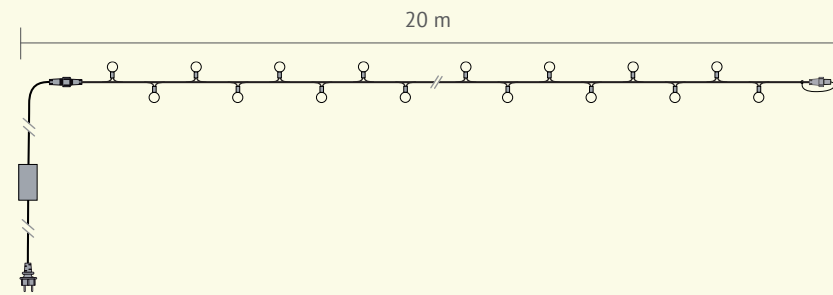

## STATICS

◀	LED	FLASH	⚡	🔌	■
20 m	160	5,6	3	FL555C	

## PRODUCT DETAILS

This auto-animated multicolour RGB garland is ideal for decorating trees or plant clusters. The pastel colour palette combined with a gentle, random animation creates a warm ambiance. Comes with a waterproof 24V transformer, making it ideal for decorations within hand's reach, in complete safety.

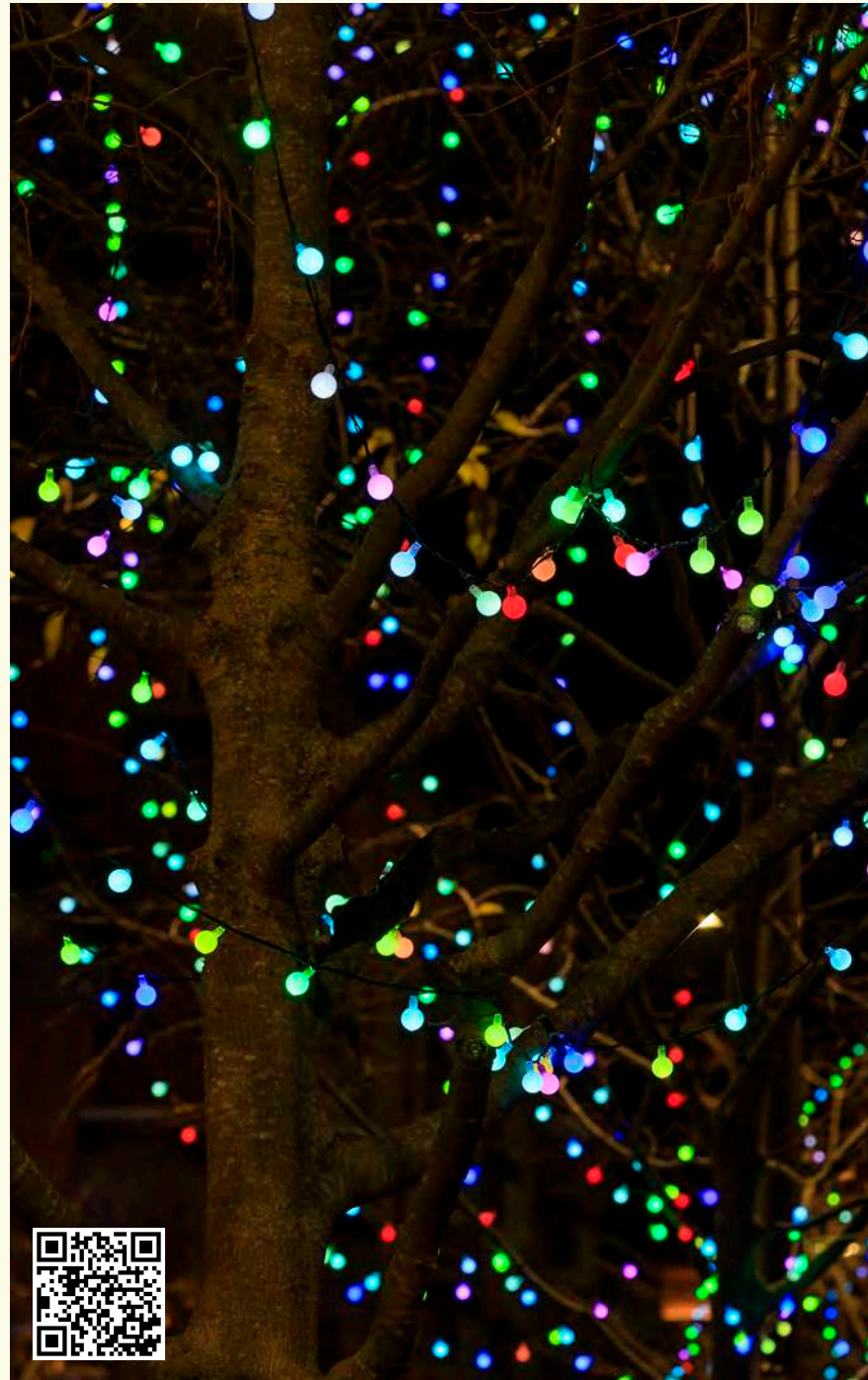

# SWAG STRING LIGHTS

*pre-lit*

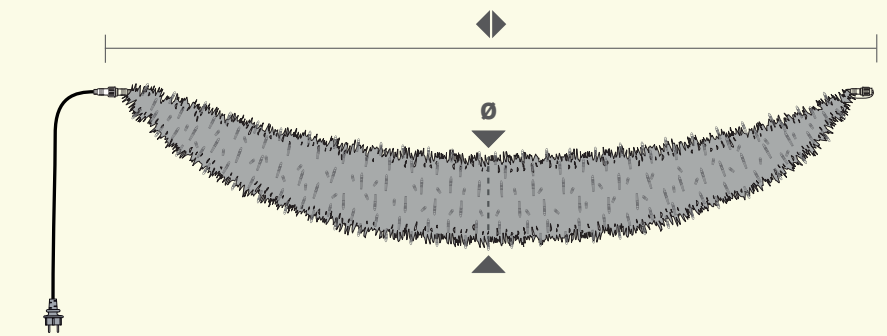

## SWAG STRING LIGHT PER UNIT

∅	◀	LED	⚡	🔌	■
35 cm	3 m	400	30	6	GP303W
35 cm	4 m	500	38	4	GP304W

## PRODUCT DETAILS

A timeless classic for traditional street decorations. Quick connection accessories, extensions, multi-socket connectors, and Octoplus 230V by Blachere®.



# FIR STRING LIGHTS

*pre-lit*



**FLASHS : set of 2 x 2,70 m**

∅	◆	LED	FLASH	⚡	🔌	■
30 cm	2,70 m	2 x 90	2 x 30	2 x 11	10	GP134LWFX

**STATICS : set of 2 x 2,70 m**

∅	◆	LED	FLASH	⚡	🔌	■
30 cm	2,70 m	2 x 120		2 x 10	10	GP134L-W

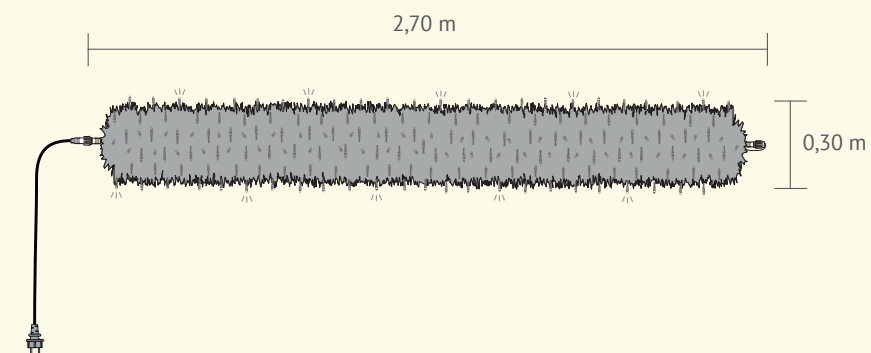

## PRODUCT DETAILS

Great classic for traditional street decorations. Sold in set of 2 fir. Quick-fit accessories, extension leads, multi-socket connectors Octoplus® 230V by Blachere®.





# JOYLIGHT® LED+ CURTAINS

## slowflash



### SLOWFLASHS

◆	◆	LED	SLOWFLASH	⚡	⏏	🔌	■	□
2 m	1,50 m	150	60	13	15	27	FL74F+	FL74BF+
2 m	1,50 m	150	60	13	15	27	FL74WF+	FL74WBF+
2 m	3 m	240	120	25	15	18	FL70F+	FL70WBF+
2 m	3 m	240	120	25	15	18	FL70WF+	FL70BF+
2 m	5 m	360	180	60	15	9	FL75F+	FL75BF+
2 m	5 m	360	180	60	15	9	FL75WF+	FL75WBF+
2 m	7 m	510	240	60	15	9	FL72F+	FL72BF+
2 m	7 m	510	240	60	15	9	FL72WF+	FL72WBF+
2 m	10 m	690	360	69	15	9	FL79F+	FL79BF+
2 m	10 m	690	360	69	15	9	FL79WF+	FL79WBF+

### ACCESSORIES REQUIRED FOR THESE REFERENCES

◆	DESIGNATIONS	⚡	■	□
1,50 m	power cable		FY08+	FY08-B+
0,20 m	bridge rectifier	690W max	FY043A+	FY043A-B+
0,20 m	bridge rectifier	230W max	FY041A+	FY041A-B+

### PRODUCT DETAILS

**INNOVATION Blachere exclusive - Guarantee 2 years (conditions : contact us)**  
 - Registered design  
 - High brightness  
 - Shock resistant IK06

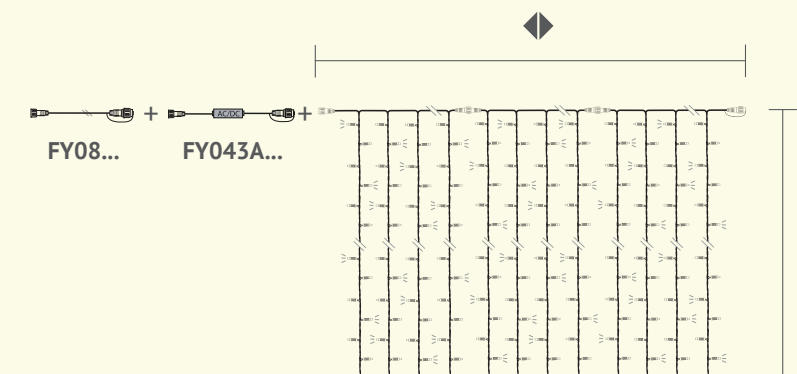

- Long lifespan  
 - Stable colour  
 - IP 66/69 protection rating. Maximum rating allowed for a 230V product  
 - Flexible connectivity thanks to the extensive Octopus 230V by Blachere range.











# JOYLIGHT® 24V CURTAINS

*flashes*

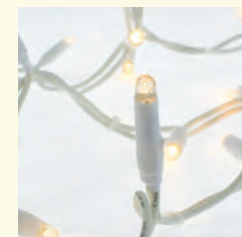

## FLASHS

◆	◆	LED	SLOWGLOW	⚡	⏏	🔌	□
2 m	3 m	300	60	12,5	15	2	FL203-FX
2 m	3 m	300	60	12,5	15	2	FL203W-FX
2 m	3 m	300	60	12,5	15	2	FL203B-FX
2 m	3 m	300	60	12,5	15	2	FL203P-FX
2 m	3 m	300	60	12,5	15	2	FL203R-FX

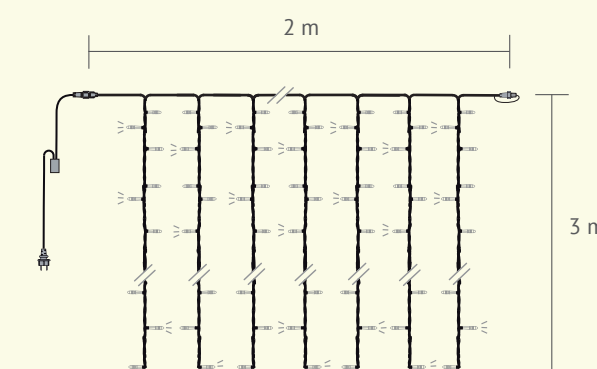

## PRODUCT DETAILS

Unbeatable value for money with proven reliability. An extensive selection of accessories and connection options with Octoplus® 230V by Blachere® accessories.



# CHERRYLIGHT® CURTAINS

*multicoloured*

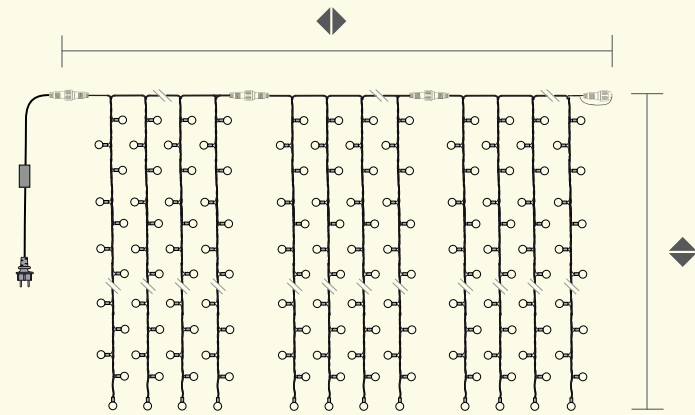

## STATICS

◆	◆	LED	⚡	⏏	📶	■
2 m	1,50 m	180	15	15	15	FL224C
2 m	3 m	300	25	15	10	FL220C

## PRODUCT DETAILS

This curtain with opaque globes diffuses a uniform light in vibrant colours that changes randomly and automatically.

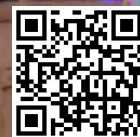
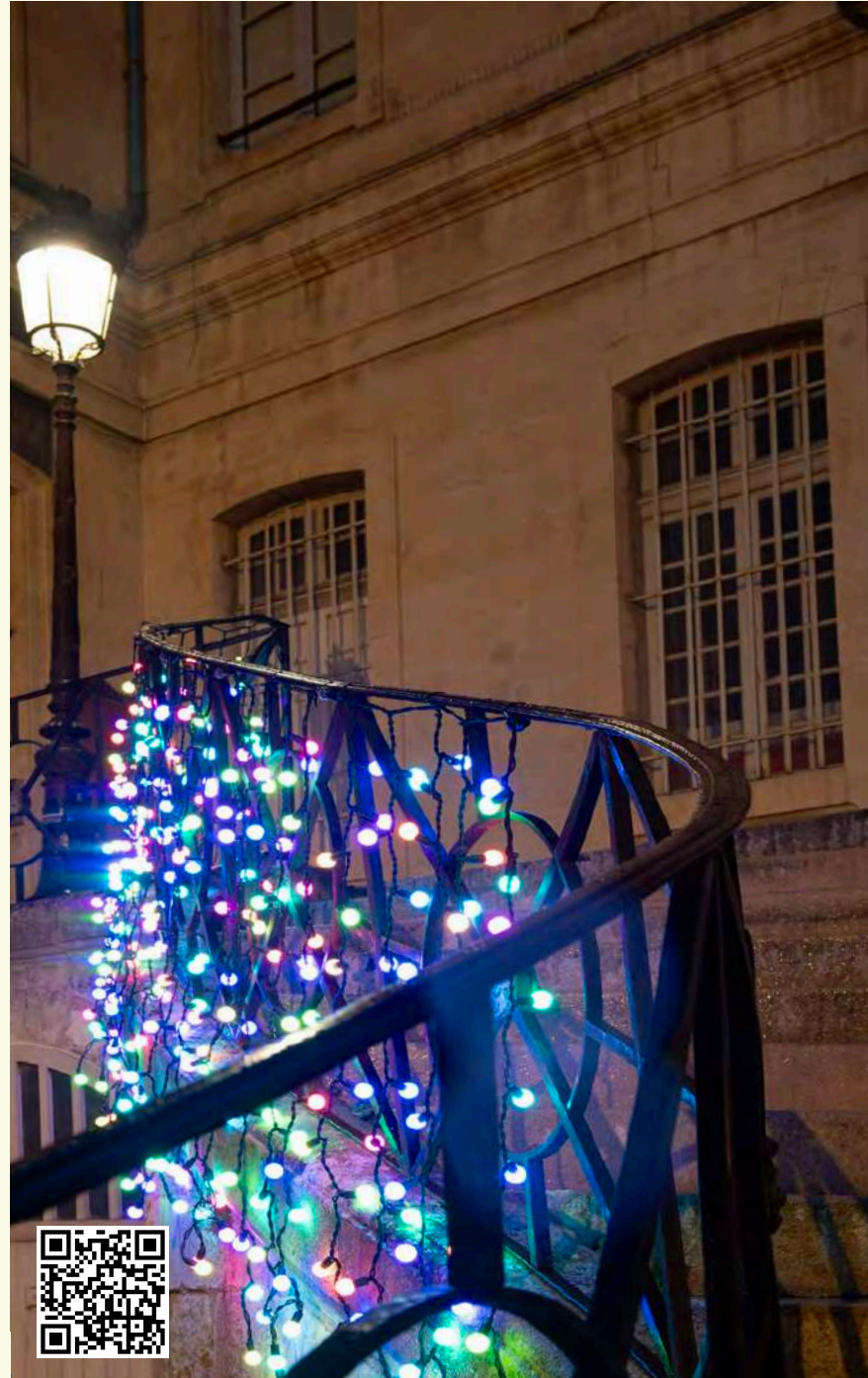

# «SCINTILLANCE» CURTAIN

*with vertical animation*

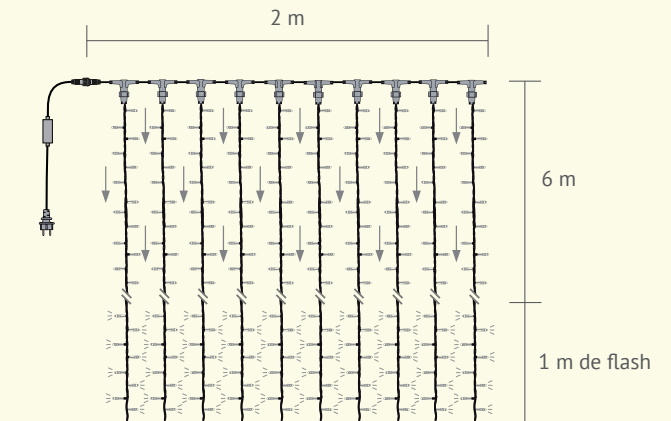
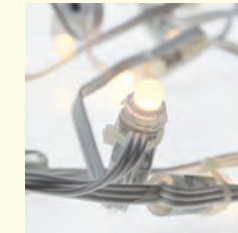

## DYNAMIC ANIMATION + FLASHS ON END OF TWIGS

◆	◆	LED	FLASH	⚡	⏏	📶
2 m	7 m	420	80	70	10	ECO216W

## PRODUCT DETAILS

Created as part of the Scintillance des Champs Élysées project in 2014, this animated curtain combines a random scrolling effect across most of the strands, ending with a section of flashes. Ideal for tall trees, it can also be used on building facades. A timeless 'classic' from our catalogue, for dynamic and elegant lighting.



# HONEYCOMB LIGHT® TREE NET

*slowflash*



## SLOWFLASHS

◆	◆	LED	SLOWFLASH	⚡	🔌	■
2 m	2 m	204	52	11	7	802W-F
2 m	3 m	306	78	16	5	803W-F
2 m	4 m		592	23	4	804WSF

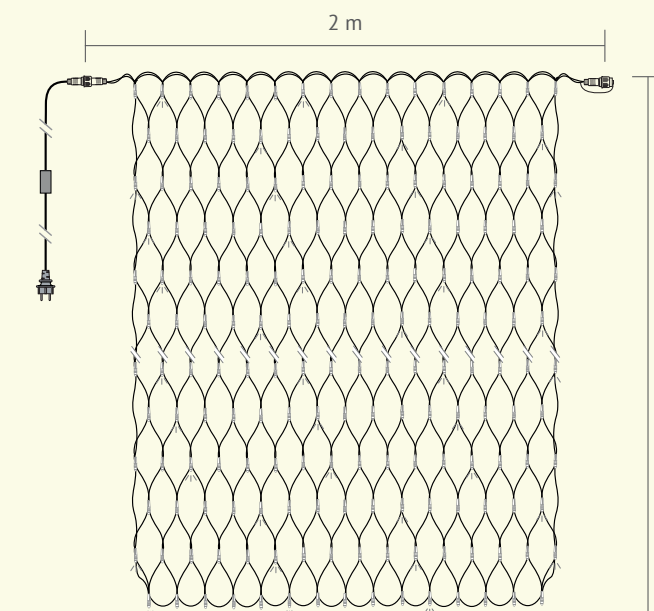

## PRODUCT DETAILS

The honeycomb-mesh net wraps easily around trunks for quick, ergonomic lighting – around ten times faster to install than a classic garland. The brown cable, which is discreet during the day, is exclusive to Blachere Illumination.

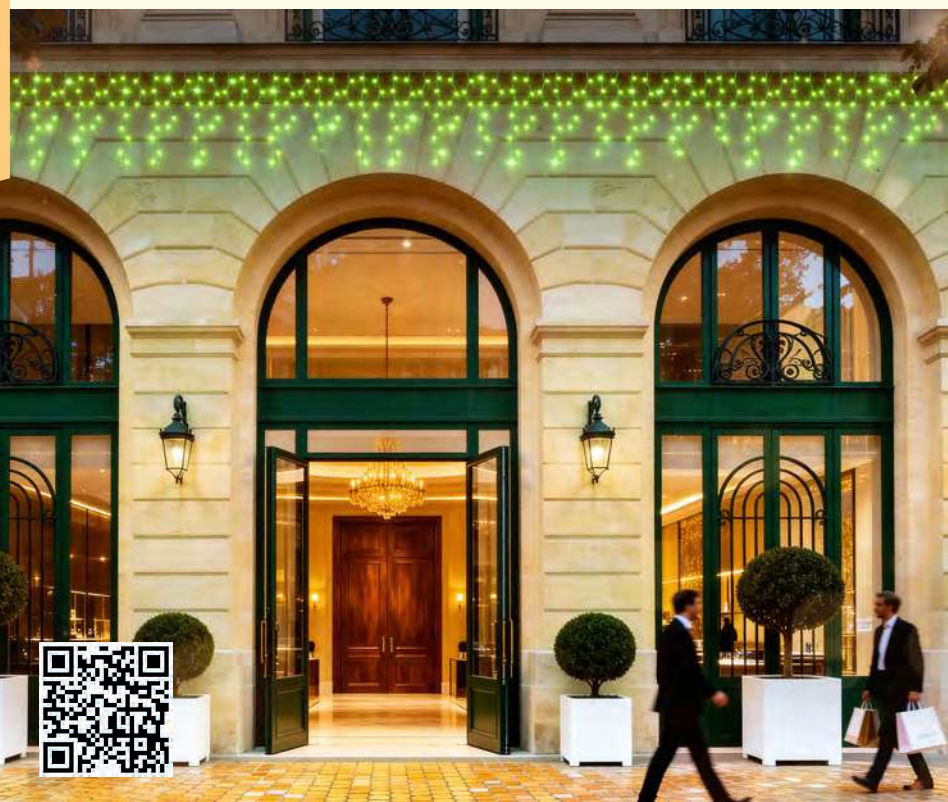

# STALACTITLIGHT iLED Color Tech by Blachere®

*RGBWW - multicoloured*

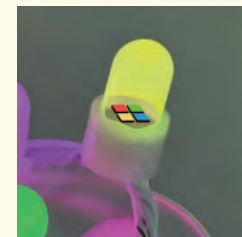

## RGBWW STALACTITLIGHT

◆	◆	RGBWW	⚡	□
7,40 m	0,8 m	256	48 48	FT-IC256B

## ACCESSORIES REQUIRED FOR THESE REFERENCES

DESIGNATION	⚡	□
transformer amplifier 12V/50W	50W	FT-TRAS50
animator / transformer 12V/50W	50W	FT-TRC50

## PRODUCT DETAILS

iLED Colour Tech Innovation by Blachere®  
 A product developed exclusively for the Champs-Élysées, now available to all our clients. Recreate the world's most beautiful avenue in your own town!  
 - New LED shape  
 - Brighter (10 lumens/pixel)

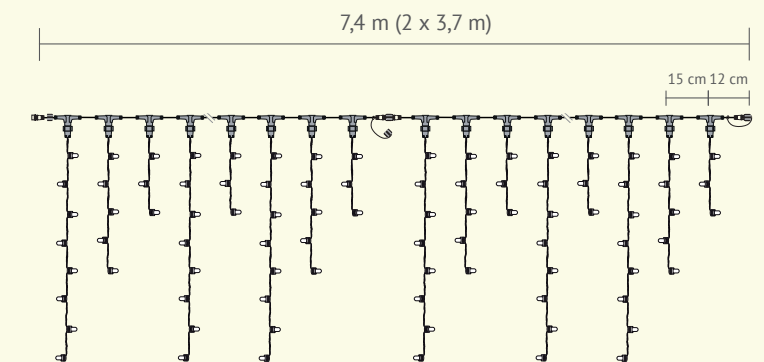





# STALACTITLIGHT® LED+

*slowflashes or statics*

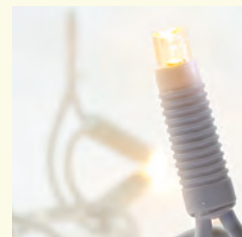

## SLOWFLASHS

◆	◆	LED	SLOWFLASH	⚡	⏏	⚡	□
4,50 m	0,80 m	120	60	13	48	20	FL390BF+
4,50 m	0,80 m	120	60	13	48	20	FL390WBF+

## STATICS

◆	◆	LED	SLOWFLASH	⚡	⏏	⚡	□
4,50 m	0,80 m	180	x	13	48	20	FL390-B+
4,50 m	0,80 m	180	x	13	48	20	FL390W-B+

## ACCESSORIES REQUIRED FOR THESE REFERENCES

◆	DESIGNATION	⚡	■	□
1,50 m	power cable		FY08+	FY08-B+
0,20 m	bridge rectifier	690W max	FY043A+	FY043A-B+
0,20 m	bridge rectifier	230W max	FY041A+	FY041A-B+

## PRODUCT DETAILS

**INNOVATION Blachere exclusive - Guarantee 2 years (conditions : contact us)**  
 - Registered design  
 - High brightness  
 - Shock resistant IK06

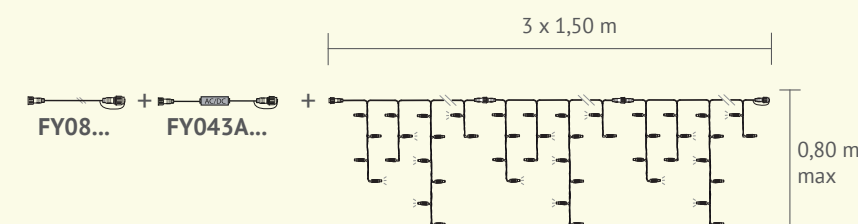

- Long lifespan  
 - Stable colour  
 - IP 66/69 protection rating. Maximum rating allowed for a 230V product  
 - Flexible connectivity thanks to the extensive Octopus 230V by Blachere range.





# LACE STALACTITLIGHT®

*slowflash effect*

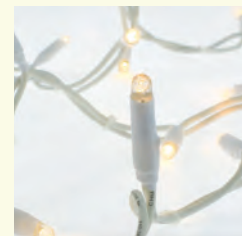

## SLOWFLASH

◀	◆	LED	SLOWFLASH	↔	⏏	☐
7,5 m	0,25 m	120	30	6	10	355-FX
7,5 m	0,25 m	120	30	6	10	355W-FX

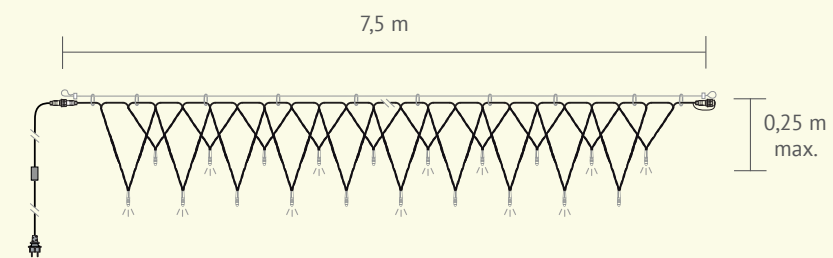

## PRODUCT DETAILS

New for 2026, our stalactite is a combination of a braid and a classic stalactite, creating a new decorative light festoon. Connectable end-to-end, it can illuminate large lengths either across streets or suspended. An alternative to our TSL braids. There is also the option of inserting small decorative elements using our Octopus system.



# ECO STALACTITES

*flashes*

- 
- rubber
- IP65
- 230V
- incl.

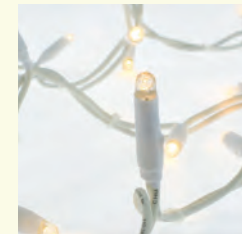

## FLASHS

◆	◆	LED	FLASH	⚡	📏	📡	🗄️
4,50 m	0,80 m	90	30	9	30	15	ECO350F
4,50 m	0,80 m	90	30	9	30	15	ECO350WF

## PRODUCT DETAILS

Unbeatable value for money with proven reliability. An extensive selection of accessories and connection options with Octoplus® 230V by Blachere® accessories.

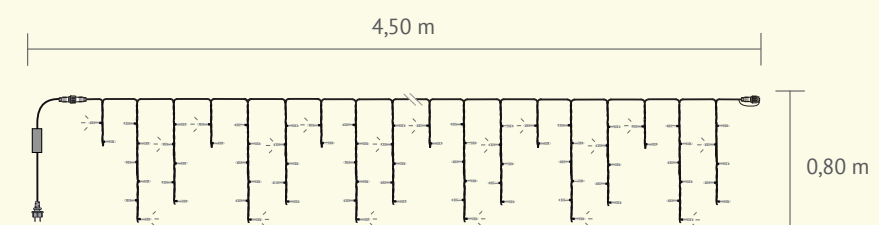



# FIR STRING LIGHTS STALACTITES

*flashes*

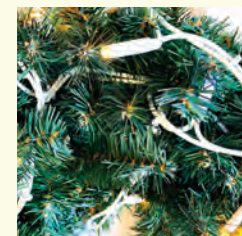

## FLASHS

∅	◆	◆	LED	FLASH	↔	⏏	⏏	□
0,14 m	4,50 m	0,60 m	156	48	13	48	15	GP138L
0,14 m	4,50 m	0,60 m	156	48	13	48	15	GP139L-W

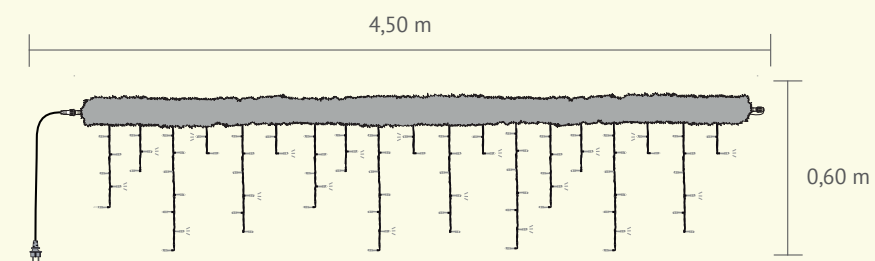

## PRODUCT DETAILS

A classic choice for traditional street decorations. Quick connection accessories, extension leads, multi-socket connectors, 230V Octoplus by Blachere®.



# LEDMOSPHERE STALACTITES

*statics*



micro steel wire

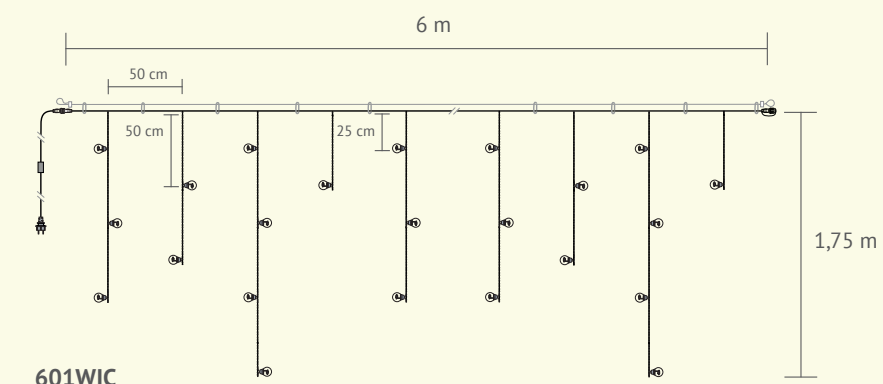

601WIC

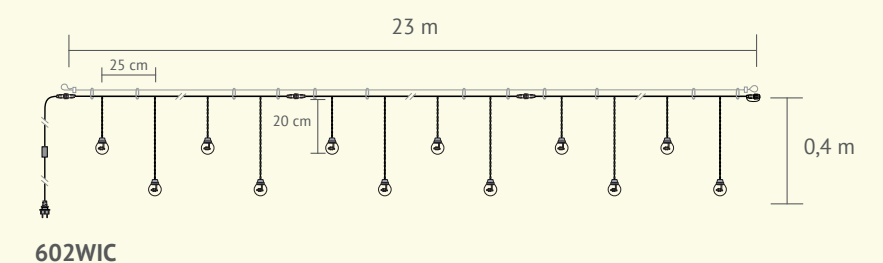

602WIC

## STATICS

◆	◆	LED	FLASH	⚡	⏏	🔌	■
6 m	1,75 m	30	x	14	12	10	601WIC
23 m	0,40 m	90	x	45	90	3	602WIC

## PRODUCT DETAILS

String lights mounted on a steel wire which will allow an easy installation and a greater resistance. Compatible with the Octoplus 230V range. Carabiners supplied.



# TREE LIGHT HP CEILING

*static*



### STATIC

◀	▶	LED	⚡	⏏	⏏	□
0,6 m	20 m	198	70	3	4	415WHP

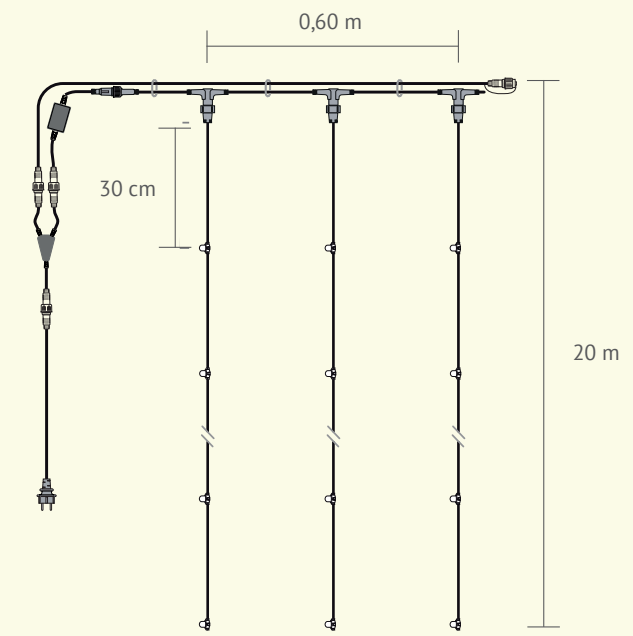

### PRODUCT DETAILS

A classic choice for traditional street decorations. Quick connection accessories, extension leads, multi-socket connectors, 230V Octopus by Blachere®.



# CEILING

*flashes or statics*



micro steel wire

## FLASHS

◆	◆	LED	FLASH	⚡	⏏	🔌	■
2 m	30 m	588	98	30	7	3	414-FX
2 m	30 m	588	98	30	7	3	414W-FX

## STATICS

◆	◆	LED	FLASH	⚡	⏏	🔌	■
2 m	30 m	686	x	30	7	3	414
2 m	30 m	686	x	30	7	3	414W

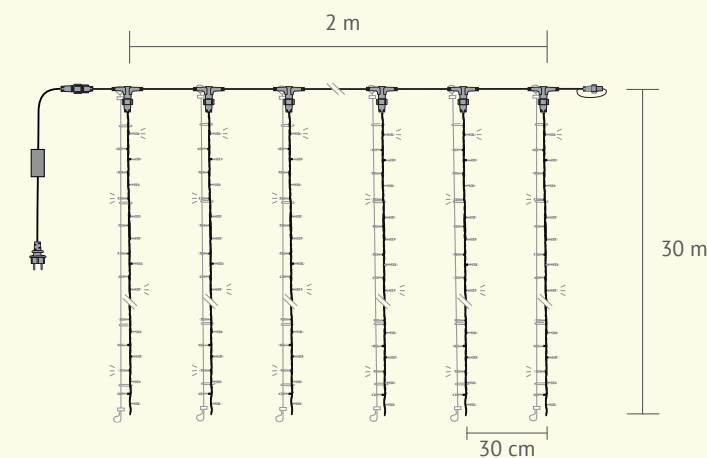

## PRODUCT DETAILS

Cover up to 180m<sup>2</sup> with a single power supply at a lower cost. The 24V/100W transformer for outdoor use, included with the 414-FX and 414W-FX string lights, allows three modules to be connected to a single transformer. Each string is reinforced with a micro-steel wire for greater durability.



# DUO COLORS® BRAIDS

## flashes

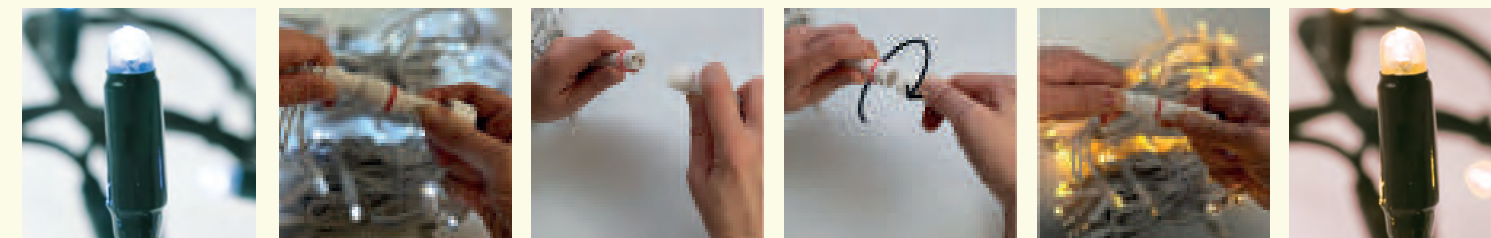

Pure white → → → → → Warm white



micro steel wire

### FLASHS

∅	◆	LED	FLASH	⚡	🔌	□
12 cm	7,50 m	192	48	12	10	TSL4WWF

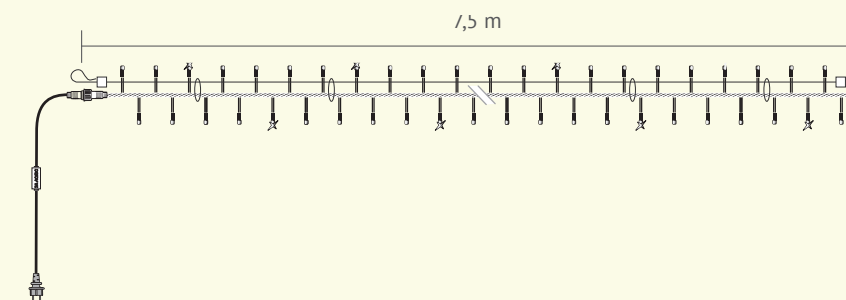

### PRODUCT DETAILS

#### 2 in 1 products!

Your garland can be either warm white or pure white. Reverse the connection to obtain pure white/pure white flash or warm white/warm white flash. See DUO COLORS® Decor Collection.

Une fille en Ville  
à 20 m  
Prêt à porter  
Chaussures  
Accessoires



PLEASE  
NO NAME



# TWO-TONE BRAIDS

*dropdown*

- 
- 
- 
- 
- 



## DROPDOWN

◆	LED	⚡	□
6 m	240	55	TSLWW-W
6 m	240	55	TSLBL-W

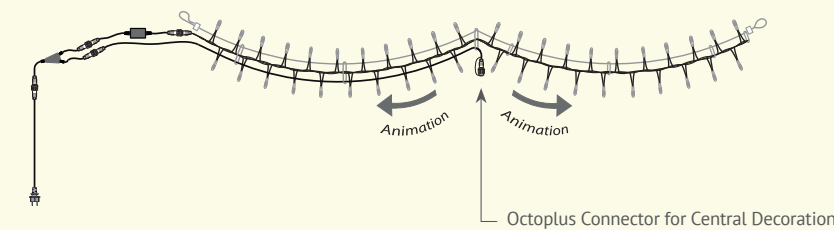

## PRODUCT DETAILS

Discover our two-tone blue/white or warm white/pure white string lights, ideal for elegant decorations. Equipped with scrolling light effects and connectable to hanging lights, they create a magical, sophisticated atmosphere for all your festive occasions.

# LED+ BRAIDS

## slowflash



micro steel wire

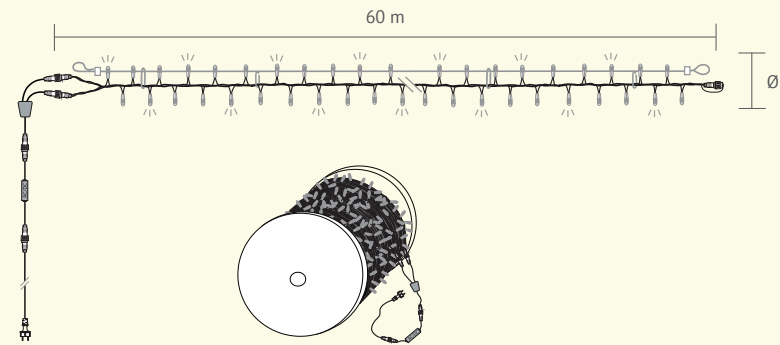

### SLOWFLASHS

∅	◆	LED	SLOWFLASH	⚡	🔌	□
6 cm	60 m	648	312	60	2	TSL60+
6 cm	60 m	648	312	60	2	TSL60W+

### PRODUCT DETAILS

«Ready-to-install» crossing with high light density. Mounted on a coated ø3mm steel cable. Features quick connection accessories, multi-socket connectors, and an animation kit.

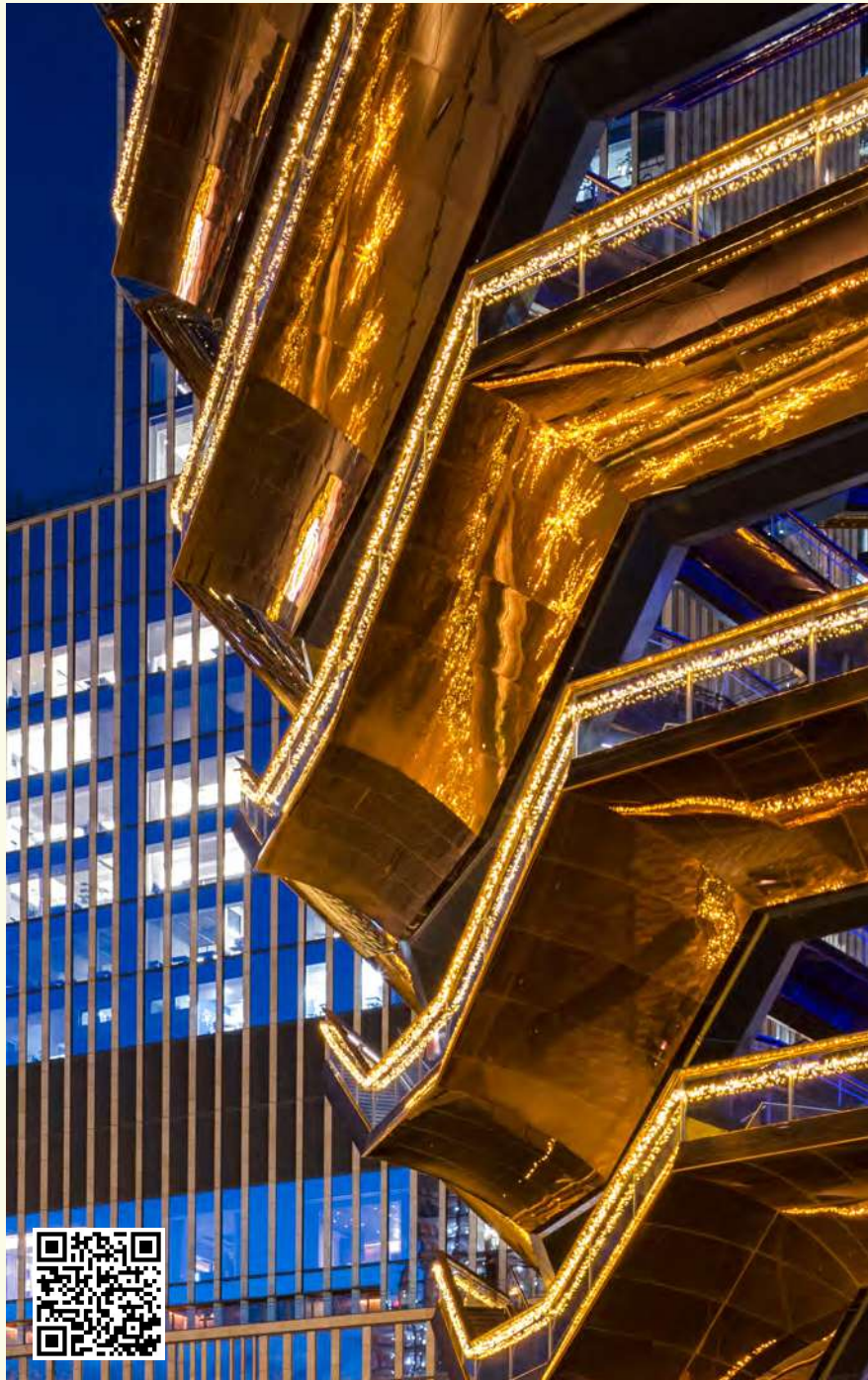

# NICIA® BRAIDS

## flash

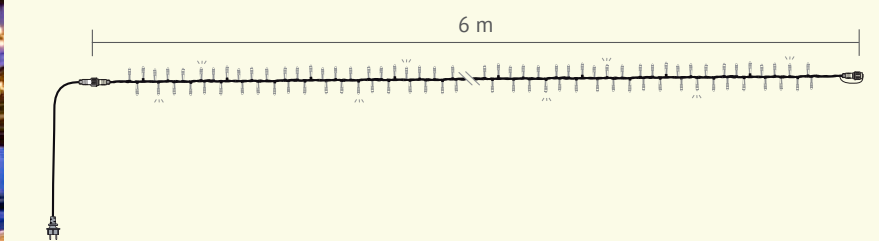

### FLASHS

∅	◆	LED	FLASH	⚡	🔌	□
6 cm	6 m	432	48	23	9	558-FX
6 cm	6 m	432	48	23	9	558W-FX

### PRODUCT DETAILS

Unbeatable value for money and proven reliability. A wide choice of accessories and connection options with Octoplus® by Blachere® accessories.

# BRAIDS

*flash or static*

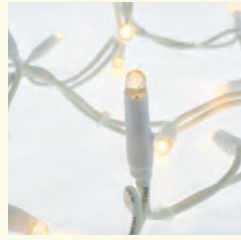

micro steel wire

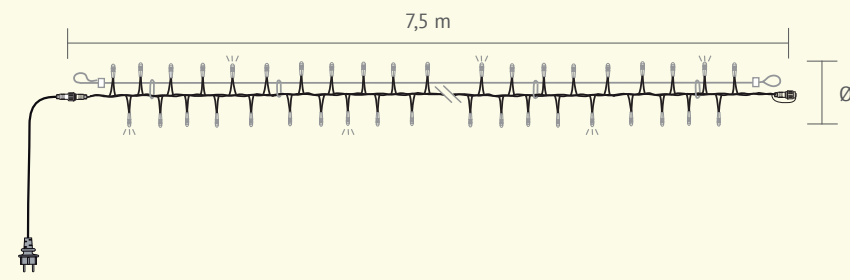

## FLASHS

∅	◆	LED	FLASH	↺	⏏	□
12 cm	7,50 m	210	30	13	13	TSL3FX
12 cm	7,50 m	210	30	13	13	TSL3WFX

## STATICS

∅	◆	LED	FLASH	↺	⏏	□
6 cm	7,50 m	240	x	13	13	TSL2
6 cm	7,50 m	240	x	13	13	TSL2W

## PRODUCT DETAILS

«Ready-to-install» crossing with high light density. Mounted on a coated  $\varnothing 3\text{mm}$  steel cable. Features quick connection accessories, multi-socket connectors, and an animation kit.

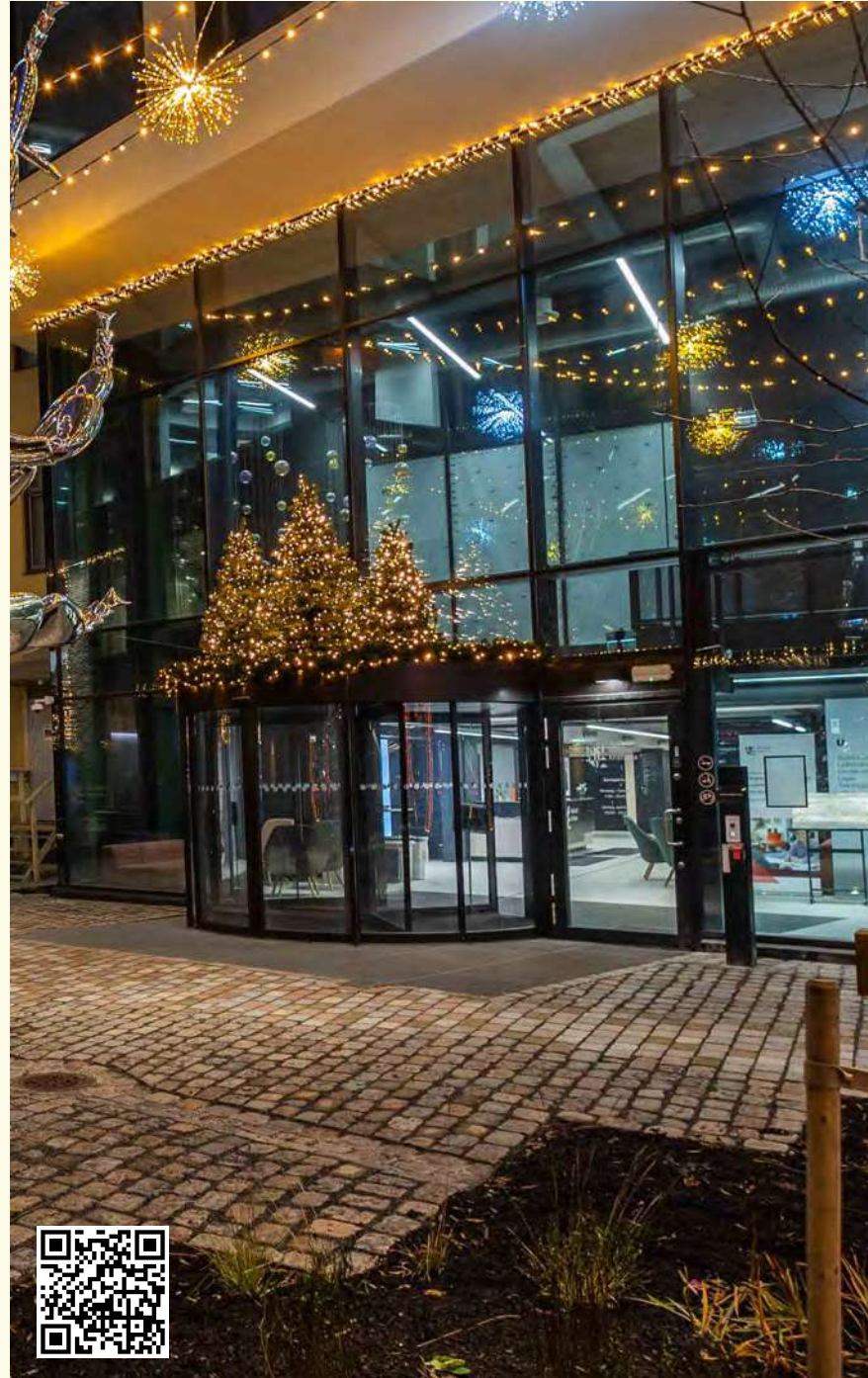

# ECO BRAIDS

*flash*

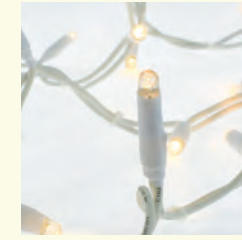

micro steel wire

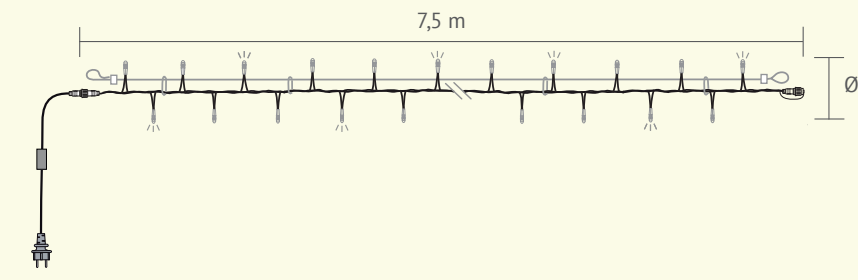

## FLASHS

∅	◆	LED	FLASH	↺	⏏	□
12 cm	7,50 m	160	20	10	15	ECOXS3F
12 cm	7,50 m	160	20	10	15	ECOXS3WF

## PRODUCT DETAILS

Unbeatable value for money and proven reliability. A wide choice of accessories and connection options with Octoplus® by Blachere® accessories.





# HANGING BOUQUETS

flashes

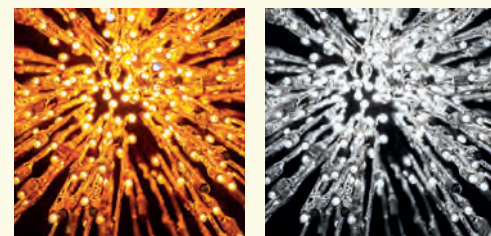

**LARGE INDOOR MODEL**



∅	◆	◆	LED	FLASH	⚡	🗄️	■	■
80 cm	x	x	441	63	18	x		
							FCL080A	
80 cm	x	x	441	63	18	x		FCL080G

**DESIGNATION** PRTR24VI

Indoor transformer for FCL bouquet - sold separately 25

**LARGE OUTDOOR MODEL**



∅	◆	◆	LED	FLASH	⚡	🗄️	■	■
80 cm	x	x	441	63	18	x		
							FCL080A-E	
80 cm	x	x	441	63	18	x		FCL080G-E

**DESIGNATION** PRTR24V

Outdoor transformer for FCL bouquet - sold separately 25

**SMALL OUTDOOR MODEL**



∅	◆	◆	LED	FLASH	⚡	🗄️	■	■
30 cm	2 m	2 m	735	105	24	5		
							FL930A-E	
30 cm	2 m	2 m	735	105	24	5		FL930G-E

**PRODUCT DETAILS**

The hanging bouquets animated with flash with a gold or silver decoration, good daytime effect. Working with a PRTR24VI or PRTR24V transformer - sold separately. Compatible with 24V Octopus extension leads.

drawing of installation:

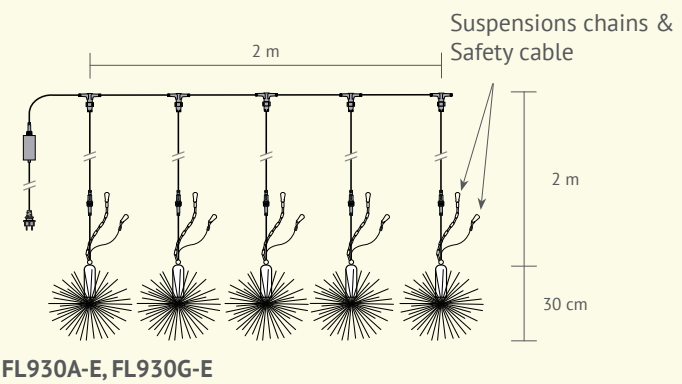
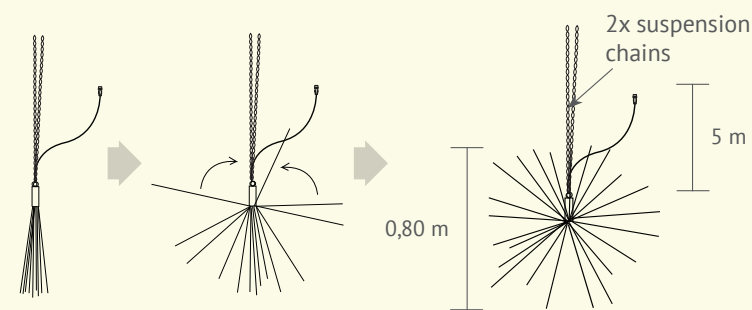

FL930A-E, FL930G-E





# TWIGS STRING LIGHTS



## SET OF 3 TWIGS

	LED		
3x1,80 m	3x161 <span style="color: grey;">●</span>	3x5	BRIN180
3x1,80 m	3x161 <span style="color: yellow;">●</span>	3x5	BRIN180W

## ACCESSORIES REQUIRED FOR THESE REFERENCES

DESIGNATION	
24V – 3 output transformer for BRIN180/180W	FY04BRIN
double output Y connector	FY030M

## PRODUCT DETAILS

**Save 40 % on installation time!**  
 Quick and easy tree wiring thanks to the double-output Y connector FY030M. Operates with 24V transformer 24V FY04BRIN. 3 outputs for twig BRIN180/180W supplied with 3 x 2m extension leads for connecting up to 6 sets of 3 branches on a single power supply.

# HANGING MOTIFS

*X-Led effect*

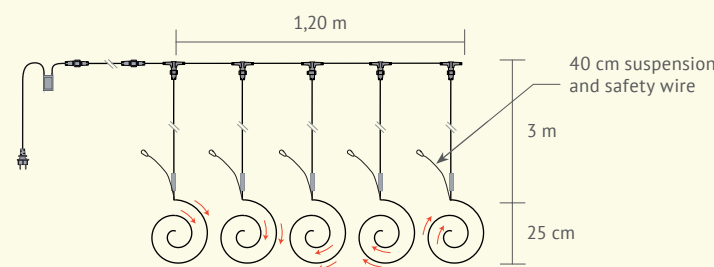
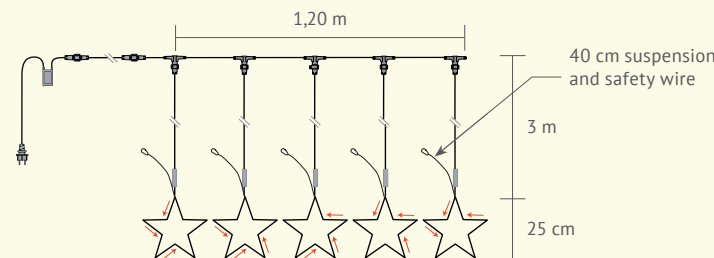

## SET OF 5 DECORATIONS

∅	◀	◆	LED	⚡	📏	🔌
25 cm	1,20 m	3 m	270	25	FXL920E	
23 x 20 cm	1,20 m	3 m	270	25	FXL920S	

## PRODUCT DETAILS

Ideal for embellishing your trees or hanging from strand lights. Enjoy exclusive Xled animations! Set includes 5 decorations. Remember to attach the mini decorations with the suspension cables supplied.



# HANGING SPARKLING STARS

*animated*



Suspensions chains & Safety cable 40 cm

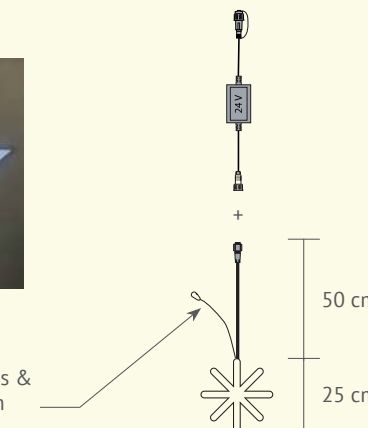

## SET OF 10 STARS

∅	◀	◆	LED	⚡	📏	🔌
23 cm	2 m	3 m	FL900S	40	10	

## SET OF 10 SNOWFLAKES

∅	◀	◆	LED	⚡	📏	🔌
25 cm	2 m	3 m	FL900WW	18	10	
25 cm	2 m	3 m	FL900E	18	10	
25 cm	2 m	3 m	FL900EW	18	10	
25 cm	2 m	3 m	FL900EM	18	10	

## INDIVIDUAL SNOWFLAKE

∅	◀	◆	LED	⚡	📏	🔌
25 cm	x	x	G-FL900	3		
25 cm	x	x	G-FL900WW	3		

## DESIGNATION

230V -> 24V transformer with Octoplus connector - sold separately

FYPRTR9B

## PRODUCT DETAILS

Discover the two-tone warm white/cool white glow: 2 effects in 1, exclusive to Blachere! A best-seller with a patented design, this product provides smooth animation and an elegant daytime effect thanks to the white polycarbonate. Easy to install on trees or ropes with the hooks included. Available individually or in packs of 10.



# HANGING BALLS

flame effect



Suspensions chains & safety cable 60 cm

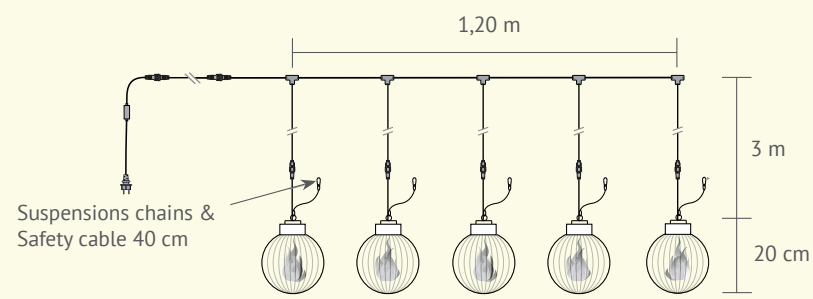

### SET OF 5 SPHERES



Ø	◆	◆	LED	⚡	📏	■
20 cm	1,20 m	3 m		18	5	FL920LU

### INDIVIDUAL SPHERE

Ø	◆	◆	LED	⚡	■
20 cm	x	x		3	G-FL920LU

### DÉSIGNATION

230V -> 24V transformer with Octopus connector - sold separately

FYPTR9B

### PRODUCT DETAILS

Perfect for decorating trees or hanging from strand lights. Recreate the warm atmosphere of candlelight with a unique sparkling animation. Add a fashionable retro touch to your decorations! Available in packs of 5 GLOBES or individually.



# HANGING BALLS

multicoloured RGB

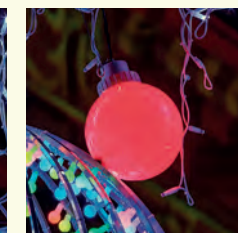
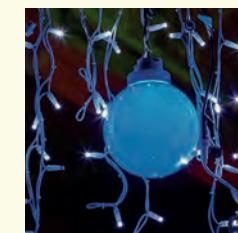

60 cm suspension and securing cable

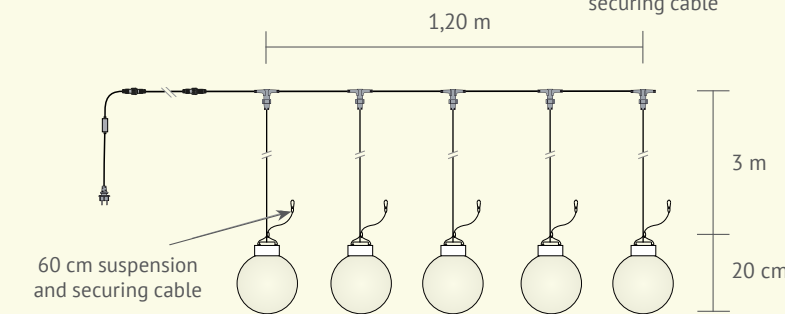

### SET OF 5 SPHERES



Ø	◆	◆	LED	⚡	📏	■
20 cm	1,20 m	3 m		24	5	FL920M

### INDIVIDUAL SPHERE

Ø	◆	◆	LED	⚡	■
20 cm	x	0,50		5	G-FL920M

### DÉSIGNATION

230V -> 24V transformer with Octopus connector - sold separately

FYPTR9B

### PRODUCT DETAILS

Perfect for decorating trees or hanging from ropes. Create a colourful pop atmosphere RGB animation, a unique effect! Available in packs of 5 GLOBES or individually.





# NOSTALGIA XL HANGING BULBS

*flash*



60 cm suspension and securing cable

### INDIVIDUAL BULB

∅	◆	◆	LED	FLASH	⚡	□
28 cm	x	0,50	100	50	4	G-FL930BB

DESIGNATION						FYPTR9B
230V -> 24V transformer with Octopius connector - sold separately						

### SET OF 4 BULBS



∅	◆	◆	LED	FLASH	⚡	⏏	■
28 cm	2 m	2 m	400	200	18	4	FL930BB

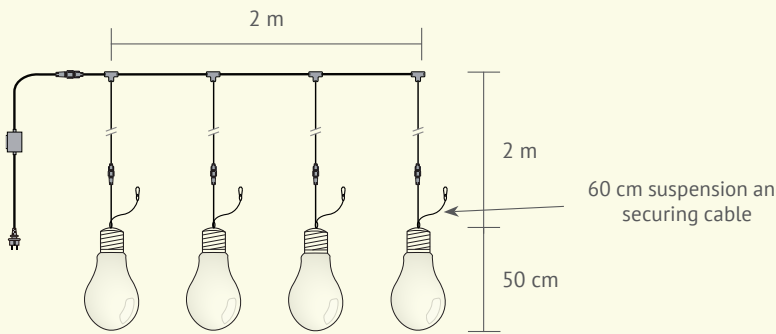
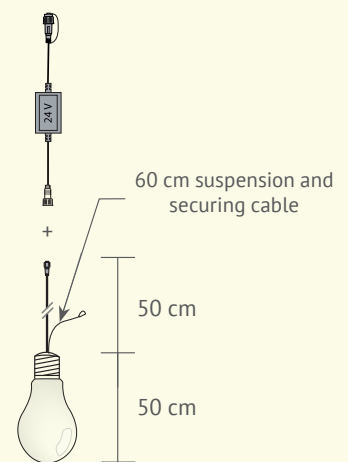

### PRODUCT DETAILS

Perfect for enhancing your trees or hanging on cables, these oversized bulbs offer a captivating sparkle. Add a trendy retro touch to your decorations! Available in a set of 4 bulbs with a transformer included, or individually. Equipped with a stainless aluminum base for optimal durability.

# HANGING SPHERES

*micro led and flashes*

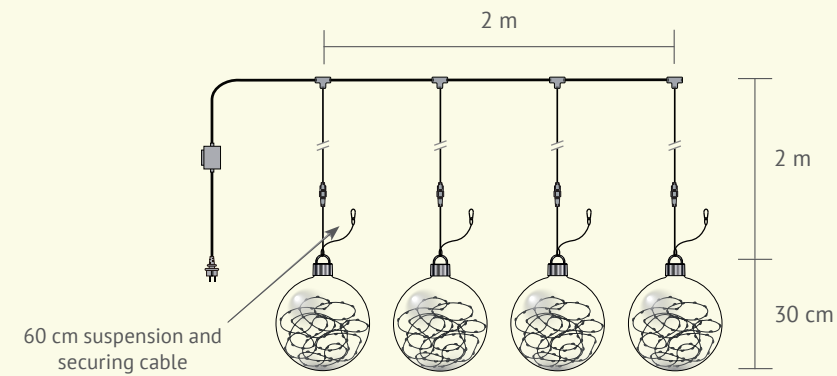
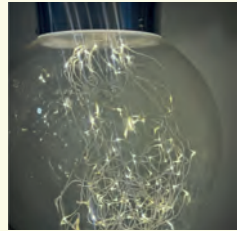

## SET OF 4 SPHERES

∅	◆	◆	LED	FLASH	⚡	⏏	■
30 cm	2 m	2 m	400 <span style="color: yellow;">●</span>	200	18	4	FL930A

## PRODUCT DETAILS

Set of 4 decorative light balls, perfect for illuminating your trees and creating a magical atmosphere. Easy to install, they give off a soft glow for your festive celebrations or seasonal decorations.



# HANGING BRANCHES

*micro led*

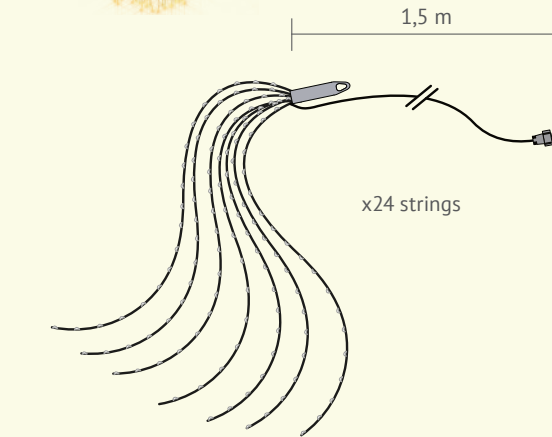

## MICRO LED

◆	LED	⚡	⏏	□	
1,2 m	288 <span style="color: grey;">●</span>	6	24	4	BRIN288
1,2 m	288 <span style="color: yellow;">●</span>	6	24	4	BRIN288W

## DESIGNATION

extension cable 2m	FY04W-PVC
--------------------	-----------

## PRODUCT DETAILS

Super easy installation. It will ideally decorate lamp posts and facades. Accessories sold separately.



# XLED HANGING STEMS

*double drop double-sided*

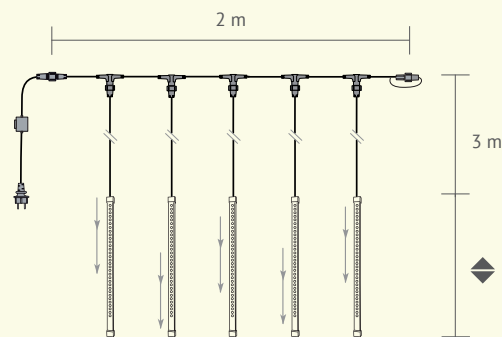

## X-LED STEM

LED	Length	LED	Flash	Power	Accessories
320	2,70 m	0,50 m	12	5	2 FXL055
480	2,70 m	0,80 m	17	5	2 FXL085

## X-LED STEM FOR B22/230V SOCKET FY03B22 ACCESSORIES

LED	Length	LED	Flash	Power	Accessories
96	0,80 m		2	x	x FXL08-B22

## DESIGNATION

Multi ends power supply

FY04FXL

## PRODUCT DETAILS

A smooth double-drop animation, exclusive to Blachere. Double-sided rods for 360-degree luminosity. Can be used for a wide range of applications, including facades, street crossings and tree decorations. Multi-output accessory FY04FXL : 20 stems on a single power supply !



# HANGING STEMS

*flashes*

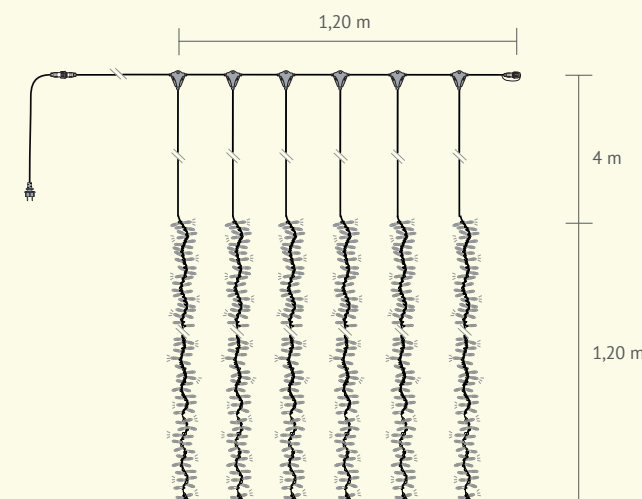

## FLASHS

LED	Length	LED	Flash	Power	Accessories
480	1,20 m	1,20 m	120	50	6 3 950-FX
480	1,20 m	1,20 m	120	50	6 3 950W-FX

## PRODUCT DETAILS

Very light products for hanging on all types of branches. Pack of 6 drop decorations.





## HANGING LIGHTS

*foldable*

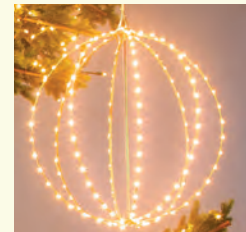

### HANGING LIGHTS FOLDABLE - 230V



Ø	◆	◆	LED	FLASH	⚡	☐
0,60 m	0,60 m	0,60 m	70 ●	6 ✨	4	G-SPHERE
0,60 m	0,60 m	0,60 m	41 ●	4 ✨	4	G-STAR

#### DESIGNATION

power cable 230V - sold separately

FY08-B+

bridge rectifier 230V - sold separately

FY041A-B+

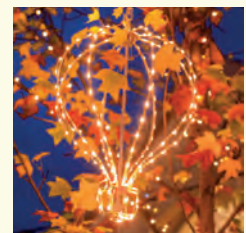
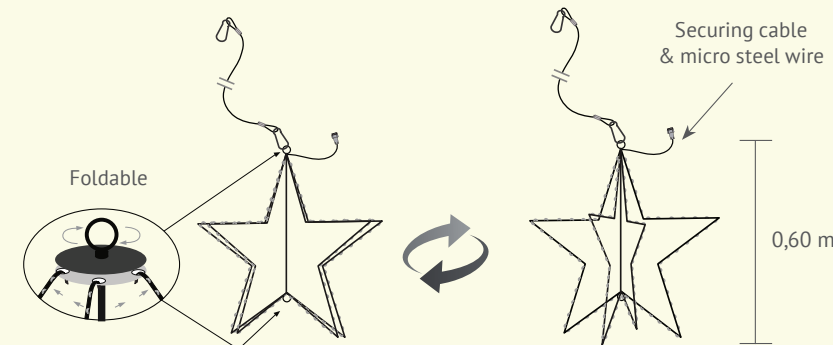

### HANGING LIGHTS FOLDABLE - 24V



Ø	◆	◆	LED	FLASH	⚡	☐
0,60 m	0,60 m	0,60 m	88 ●	x	10	G-STAR+
0,60 m	0,60 m	0,60 m	88 ●	x	10	G-STARW+
0,60 m	0,60 m	0,60 m	136 ●	x	12	G-MONT+
0,60 m	0,60 m	0,60 m	136 ●	x	12	G-MONTW+
0,60 m	0,60 m	0,60 m	144 ●	x	12	G-SPHER+
0,60 m	0,60 m	0,60 m	144 ●	x	12	G-SPHERW+

#### DESIGNATION

transformer - sold separately

PRTR24V

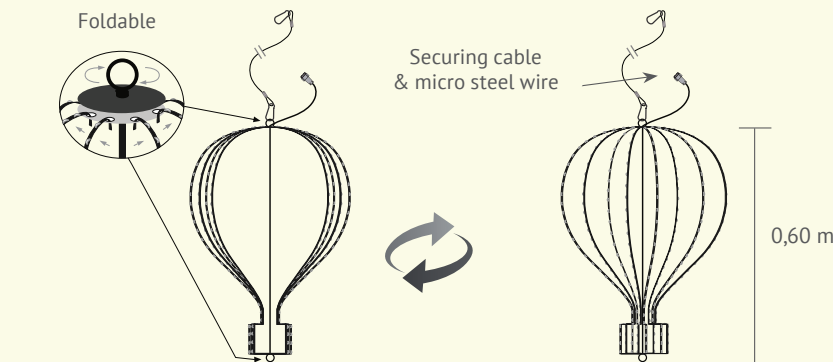

#### PRODUCT DETAILS

These foldable suspensions are aesthetic by day thanks to the white lacquering of the metal structures (available in Led Classic or Micro light + PRO). Power supply sold separately. Compatible with the entire range.



# FILS LUMIÈRE®

## statics

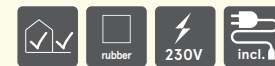

### FILS LUMIÈRE® ÉCO

∅	↕	LED	LED DENSITY/m	⚡	IP	
12 mm	roll of 90 m	☉	30	3	55	NL5011
12 mm	roll of 90 m	☼	30	3	55	NL5011W
12 mm	roll of 90 m	☀	30	3	55	NL5012
12 mm	roll of 90 m	☁	30	3	55	NL5014
12 mm	roll of 90 m	☁	30	3	55	NL5016
12 mm	roll of 90 m	☀	30	3	55	NL5013

### FILS LUMIÈRE® PLATINIUM

∅	↕	LED	LED DENSITY/m	⚡	IP	
12 mm	roll of 50 m	☉	30	4	66-69	NLEDU51
12 mm	roll of 50 m	☼	30	4	66-69	NLEDU51W
12 mm	roll of 50 m	☀	30	4	66-69	NLEDU52
12 mm	roll of 50 m	☁	30	4	66-69	NLEDU54
12 mm	roll of 50 m	☁	30	4	66-69	NLEDU56
12 mm	roll of 50 m	☀	30	4	66-69	NLEDU53

### FILS LUMIÈRE® DUO COLORS®

∅	↕	LED	LED DENSITY/m	⚡	IP	
13 mm	roll of 25 m	☉☼	30	3,5	66	NLEDWW

### PRODUCT DETAILS

**FILS LUMIÈRE® platinum :**  
Ideal for showcasing facades. Comes with 3 special LED power supplies, 3 end caps and 3 connectors. Strictly for professional use, not for retail sale in shops.

### FILS LUMIÈRE ÉCO - 30 Leds/m



### FILS LUMIÈRE PLATINIUM - 30 Leds/m



### FILS LUMIÈRE DUO COLORS - 30 Leds/m



**FILS LUMIÈRE® Duo Colors® : 2 in 1 products!**  
Your string lights can be either warm white or pure white. Reverse the connection to get pure white or warm white.



# BUNCH LIGHT® BOUQUETS

with RGBWW LEDs

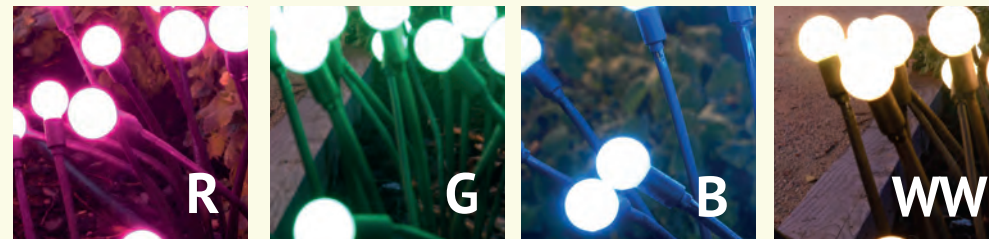

## RGBWW LED

◀	▶	LED	⚡	☑	■
6 m	0,6 m	48	8,7	3	KBRGBWW

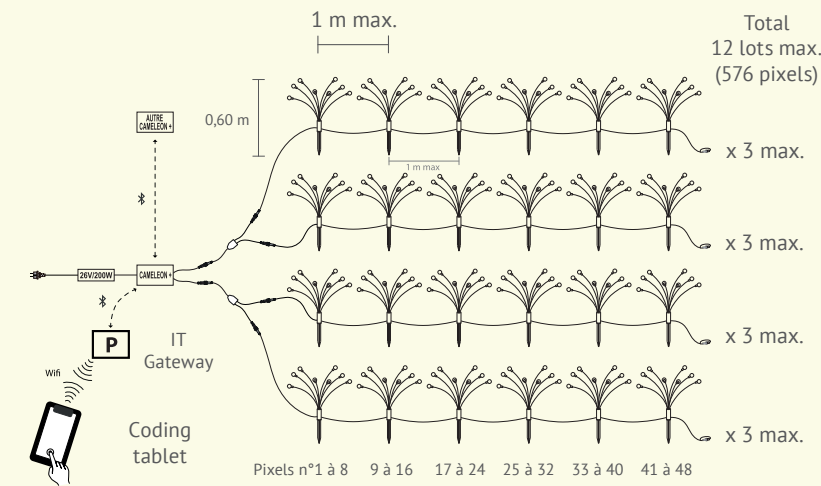

## PRODUCT DETAILS

Our new Bunch Light® RGBWW Bouquets can be placed on the floor to create animated, multi-coloured lighting surfaces. They can be custom-controlled to create an overall lighting design. Each bead can be controlled like a pixel to create a multicoloured field of light. The rods are flexible and move with the wind, creating an animated and truly magical display. This product is sold in packs of 6 bouquets, each made up of 8 RGBWW beads. If your project requires a customised analysis, please contact your account manager.

# HANGING BALLS

*inflatable*



Using a conventional inflation gun

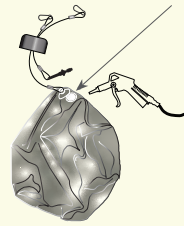

Suspension sling and securing with carabiner

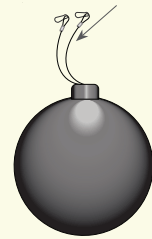

## SET OF 4 BALLS

Ø	LED	RÉFÉRENCES
0,5 m		BG50-1
0,5 m		BG50-2
0,5 m		BG50-3
0,5 m		BG50-4

## PRODUCT DETAILS

Passive decorative balls, ideal for decorating ceilings or trees by day or night. Inflates on site with a simple compressor. Set of 4 balls, for outdoor use.



# PROJECTORS & WALL-WASHED

*RGBW-DMX*



HLPRJDMX



PRJR4-DMX



PRJP5-DMX

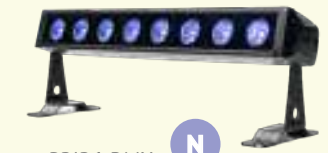

PRJR6-DMX

## RGBW WALL-WASHES

◄	◆	LED	↵	REFERENCES
0,50 m	0,40 m	8	40	PRJR6-DMX
1,00 m	0,72 m	16	75	PRJR4-DMX

## RGBW PROJECTORS

■	◆	◆	LED SMD	↵	REFERENCES
170 mm	330 mm	210 mm	15	115	PRJP5-DMX
150 mm	210 mm	120 mm	6	35	HLPRJDMX

## DESIGNATIONS

	REFERENCES
DMX extension lead - 6m	FY5P-DMX
DMX signal extension lead - 6m	FY5S-DMX

## PRODUCT DETAILS

Range of RGB strip lights. Perfect for facades or monument illuminations. Use of the SMD RGB led for a better lighting result.



## LED PROJECTORS

### *round*



#### ROUND SPOTLIGHTS FOR TREES (SET OF 2)

◆	LED	⚡	REFERENCES
180 x 55 x 24 mm	2 x 6 <span style="color: blue;">●</span>	2 x 6W	PRJA
180 x 55 x 24 mm	2 x 6 <span style="color: yellow;">●</span>	2 x 6W	PRJA-W

#### ACCESSORIES REQUIRED FOR THESE REFERENCES

DESIGNATIONS	REFERENCES
black switch-mode power supply 24V dc 25W (for a set of 2)	PRTR24N
elastic strap for PRJA-W and PRJA projectors	FYSHOW
protective and adhesive foam (set of 10)	FY-MOUS

#### PRODUCT DETAILS

Light up the trunks or branches of your trees with our round micro spotlights! Mini size but super powerful! Bright, elegant and easy to install. Totally safe for the public (24V) and the trees (elastic ties +protective foam).



## LED PROJECTOR

### *decorative*



#### LED DECORATIVE SPOTLIGHT - UNIT - IP65 - CLASS 1

■	◆	◆	LED SMD	⚡	REFERENCES
77 mm	66 mm	95 mm	6 <span style="color: yellow;">●</span>	6	PRJP-03W+

#### PRODUCT DETAILS

Decorative spotlight, ideal for creating a soft, warm atmosphere.

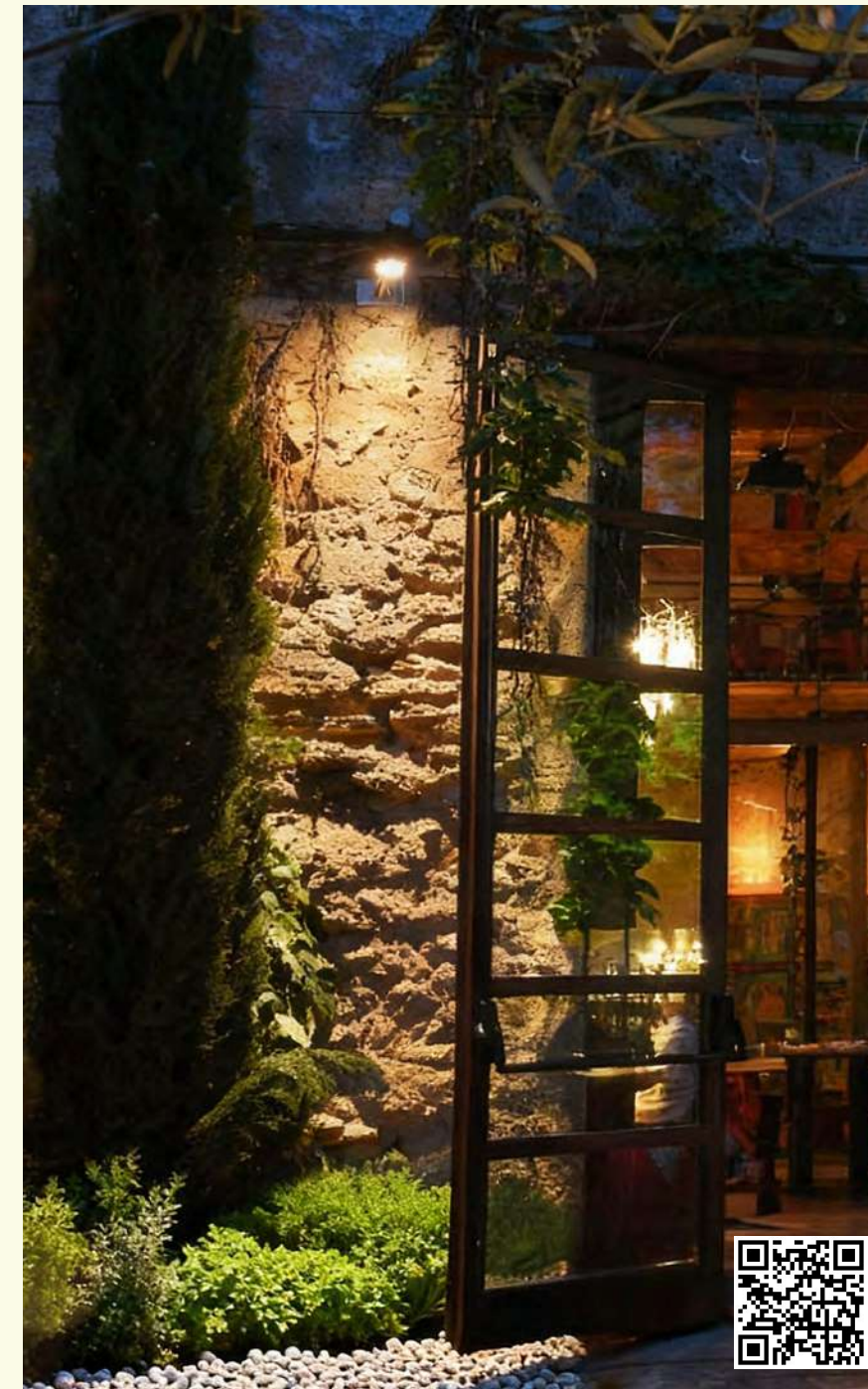

# GOBO PROJECTORS



GOBO pattern included :



## PROJECTEUR GOBO\*

Ø	◆	LED	↙	REFERENCE
130 mm	x 310 mm	1 ●	75	PRJPGOBO3

\*20° focal length - Weight: 3.3 kg.

Throw ratio (distance/image size):

- 3 m for 1,10 m
- 5 m for 1,80 m
- 10 m for 3,60m

## PRODUCT DETAILS

Rotating function with 3 speeds and fixed position. Includes 4 gobo lenses (Blue Stars, White Snowflakes, Santa Claus - Sleigh, Pink October). Supplied in a metal case for storage and transport.



# ACCESSORIES & technical solutions

# OUR STEERING SOLUTIONS

**It's time to step up the smart city movement to save more energy.**

Eco-designed equipment that is sustainable and smart energy management are part of any global eco-friendly urban policy. Blachere Illumination is committed to working alongside cities and developing innovative solutions to protect our planet and our future.

With our lighting management systems, you can remotely manage lighting with a single click. Whether it's with **our range of timer boxes or our MASTER+SAVER global control system on the next page.**

This makes it easier for the city to manage its electricity resources in line with its ecological and sustainable development aspirations.



## ON/OFF BOX WITH REMOTE CONTROL

When you fit your set with this remote control switch, you can install and connect your set to the public lighting system in advance and switch it on manually with the remote control on the day of the lighting show, without having to interact with the box installed on lighting set.

Box ref: **TERUP**  
Remote control ref: **TERUP-C** (can control multiple TERUP boxes)

- SIMPLE **ON/OFF** CONTROL
- WORK **VIA REMOTE CONTROL**

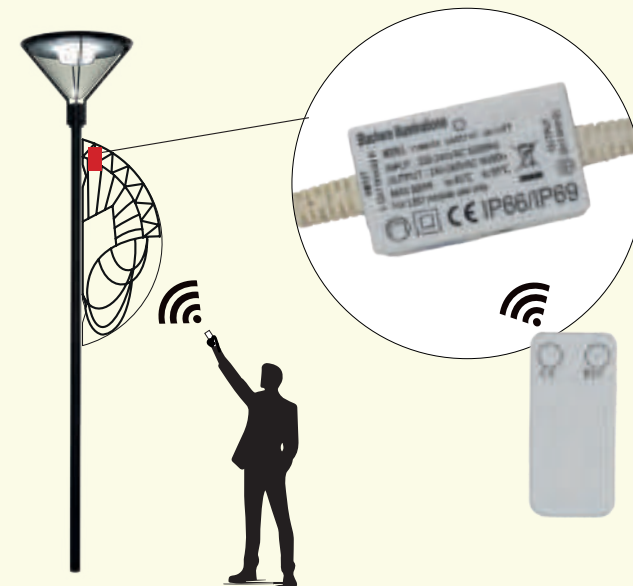

## TEMPO 2 BOX UNIVERSAL & 7-HR PROGRAMMABLE

When you fit your set with the TEMPO2 box, you can disconnect it from the public lighting network. Sets are switched off automatically after 7 hours, from the moment the street lighting switched on. By connecting a TERUP ON/OFF box upstream of this box, you can trigger the timer using the remote control.

Compatible with Octoplus and/or **any other decor.**  
Box ref : **TEMPO2**

- AUTOMATIC **7-HOUR** TIME DELAY
- CONTROL IS **ON THE BOX**



## TEMPO+ BOX PROGRAMMABLE FROM 5 TO 10 HRS

When you fit your set with the TEMPO+ box, you can disconnect it from the public lighting network and can adjust the lighting times you want and programme the lights to go out. A long press means you can select 5, 6, 7, 8, 9 or 10 hours of illumination followed by automatic switchoff. By connecting a TERUP ON/OFF box upstream of this box, you can trigger the timer with the remote control. Octoplus compatible.

Box ref : **TEMPO+**

- TIME DELAY SELECTABLE **BETWEEN 5 AND 10 HOURS**
- CONTROL IS **ON THE BOX**

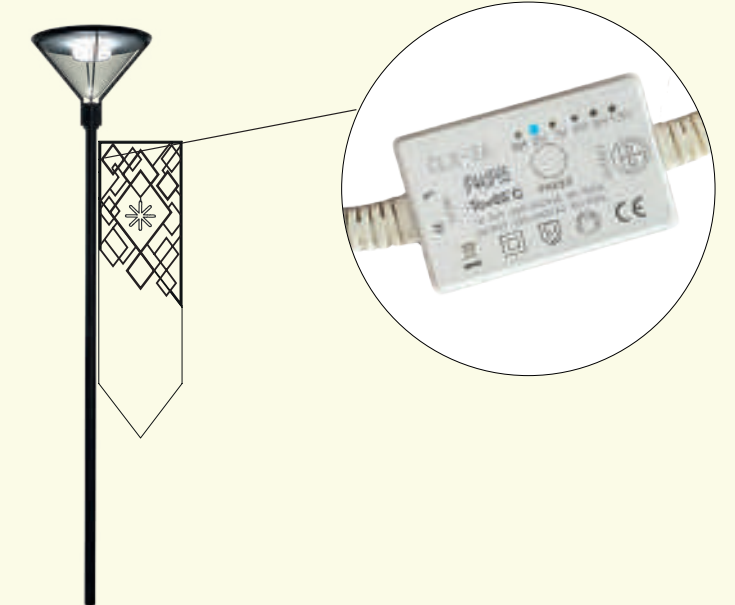

# MASTER+SAVER SYSTEM

Fit your light displays with SAVER boxes. One of the lighting sets will be «group leader» and will be equipped with a MASTER box. The MASTER box can be programmed with the switch-on times/days and will communicate the same information to all the SAVERS via Bluetooth.

The distance between SAVER and MASTER must not exceed 50m.

If two sets are more than 50m apart, you will need to make a new group with a new MASTER box. You also need to be close to the MASTER, with your phone in your hand and the application open, to be able to control your sets.

Lighting sets can be pre-programmed in our workshops or programmed by the customer themselves using the dedicated mobile application.

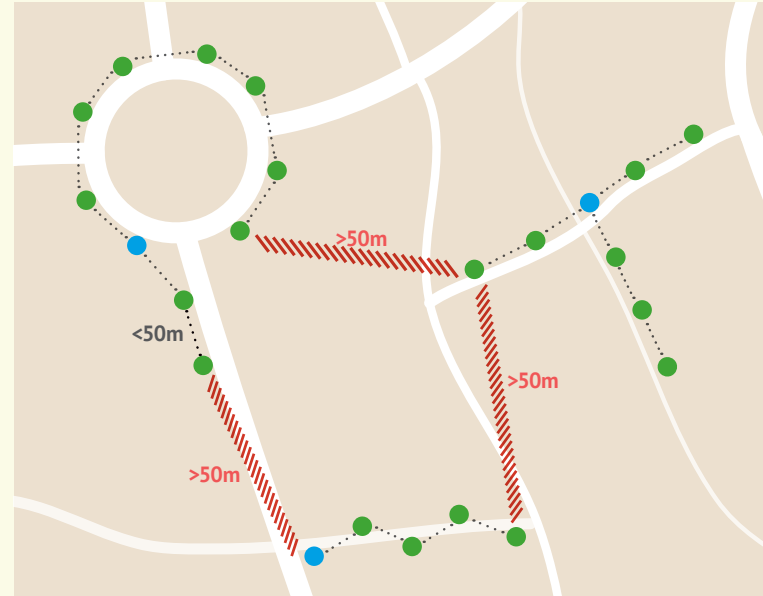

- SUPER EASY CONTROL VIA **MOBILE** APPLICATION
- CREATION OF **SET GROUPS**
- PROGRAMMING OF **SWITCH-ON DAYS AND TIMES**
- MANAGEMENT OF **SWITCH-OFF TIMES FOR ENERGY SAVINGS**
- **SECURE W - DATA PROTECTION**



# OCTOPLUS by Blachere®

exclusive

Octoplus is the connector that enables fast and multiple connection between our decorations and most of our range of string lights. Each item that is marked "Octoplus"

can therefore be connected to another "Octoplus" item. This means the combination of items is infinite just by simplifying the electrical connections.



**Connector 230V Octoplus by Blachere®**  
Protection rating IP67, according the European standard EN60529 on the degree of protection provided by enclosures.



**Connector 24V Octoplus by Blachere®**  
Protection rating IP67, according the European standard EN60529 on the degree of protection provided by enclosures.



**Special connector RGBWW 12V**  
Protection rating IP67, according the European standard EN60529 on the degree of protection provided by enclosures.



## EXAMPLE FOR A TREE

REFERENCE	QUANTITY	PAGE	REFERENCE	QUANTITY	PAGE
FY08-B+	1	278	FYPRT9	1	280
FY043A-B+	1	278	G-FL900	1	251
FY01-3+	2	278	FY03B22	2	279
BTX8	1	278	FXL08-B22	1	258
508R-FX	10	183	F722-L	10	193
FY030+	4	278			

## EXAMPLE FOR A TRANSVERSE MOTIF

to be mounted on PVC-coated steel cable

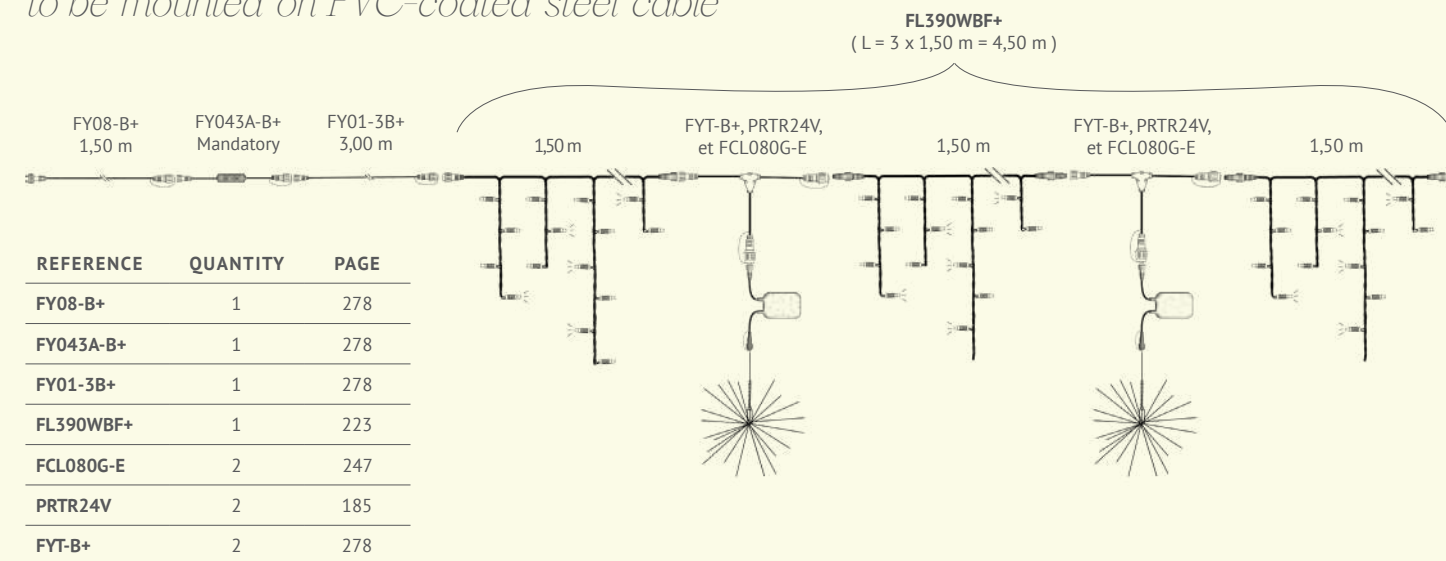

## EXAMPLE FOR A WIDTH OF 4,50M

to be mounted on PVC-coated steel cable

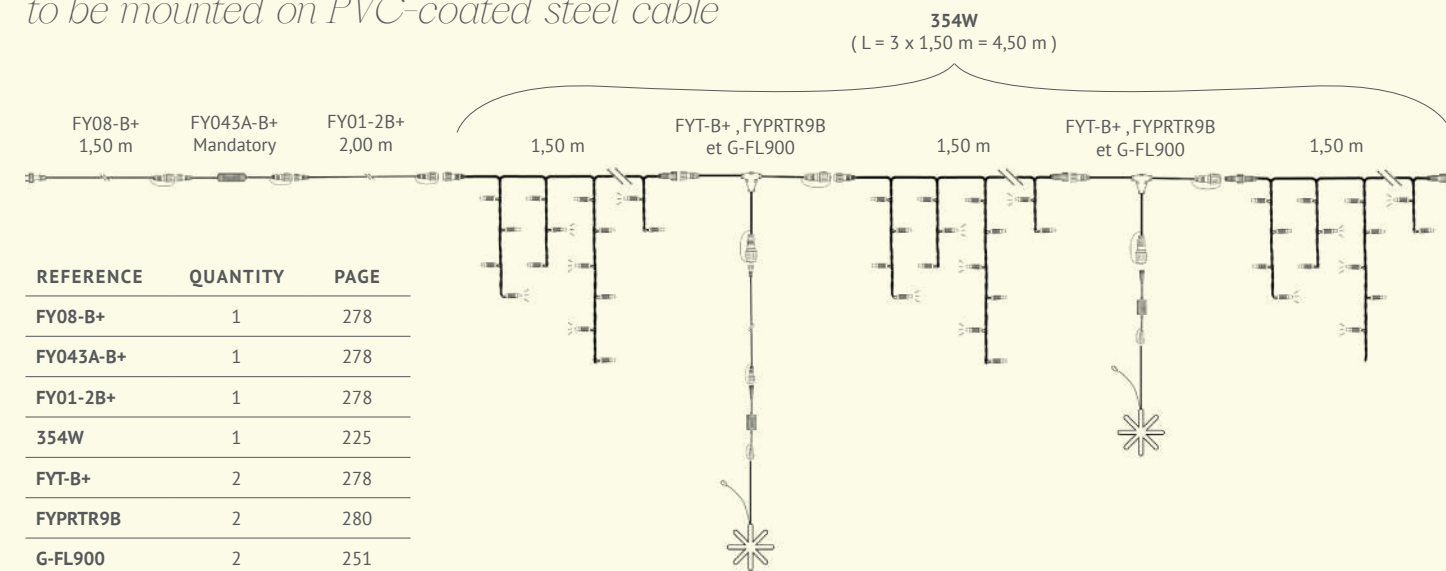

# OCTOPLUS by Blachere®

connexions 230V



DIAGRAM / PICTURE	DESCRIPTION	OBS	■	□	■
	Power cable 230V - 1.5m - H05RN-F - 2x1mm <sup>2</sup> with male plug and female Octoplus connector	Euro	<b>FY08+</b>	<b>FY08-B+</b>	-
		UK	<b>FY08-UK+</b>	<b>FY08-BUK+</b>	-
		Swiss	<b>FY08-S+</b>	<b>FY08-BS+</b>	-
		Wieland	<b>FY08-W</b>	<b>FY08-BW</b>	-
	AC/DC bridge rectifier (compulsory) for LED+ with Octoplus connector (M+F)	1A/230W	<b>FY041A+</b>	<b>FY041A-B+</b>	-
		3A/690W	<b>FY043A+</b>	<b>FY043A-B+</b>	-
	Octoplus extension 230V - H05RN-F - 2x1mm <sup>2</sup>	1m	<b>FY01-1+</b>	<b>FY01-1B+</b>	-
		2m	<b>FY01-2+</b>	<b>FY01-2B+</b>	-
		3m	<b>FY01-3+</b>	<b>FY01-3B+</b>	-
		5m	<b>FY01-5+</b>	<b>FY01-5B+</b>	-
		10m (2x5m)	<b>FY01-10+</b>	<b>FY01-10B+</b>	-
	Set of 5 end-caps plugs	-	<b>FY1C+</b>	<b>FY1CB+</b>	-
	T connector 230V (M+F/F)	-	<b>FYT+</b>	<b>FYT-B+</b>	-
	Y connector 230V (M+F/F)	-	<b>FY030+</b>	<b>FY030-B+</b>	-
	W connector 230V (M+F/F/F)	-	<b>FY031+</b>	<b>FY031-B+</b>	-
	Collector - 230V - H05RN-F L = 2 x 1.60m = 3.20m 20cm between connectors with 16 sockets and steel wire with PVC-coating 690 W max in total	-	<b>FY023+</b>	<b>FY023-B+</b>	-

DIAGRAM / PICTURE	DESCRIPTION	OBS	■	□	■
	IP66 multi-socket box with 4 Octoplus (F) outputs and one Octoplus (M) input	690W max.	<b>BTX4</b>	-	-
	IP66 multi-socket box with 8 Octoplus (F) outputs and one Octoplus (M) input	690W max.	<b>BTX8</b>	-	-
	230V adaptor Sparklight and Stalactites (connector 2017 -> connector 2018)	-	-	<b>FY230F2-B</b>	<b>FY230F2</b>
	230V adaptor Sparklight and Stalactites (connector 2018 -> connector 2017)	-	-	<b>FY230M1-B</b>	<b>FY230M1</b>
	Socket B22 with M/F Octoplus connector	5W max.	<b>FY03B22</b>	<b>FY03B22-B</b>	-
	Elasticated "SPECIAL TREE" connector to let the tree grow without any restrictions	set of 5	<b>FY07A</b>	-	-
	20cl tube of silicone sealant for full sealing of connectors (extreme environment)	-	<b>NLC60</b>	-	-
	Protective and adhesive foam	-	<b>FY-MOUS</b>	-	-

# OCTOPLUS by Blachere®

connexions 24V



DIAGRAM / PICTURE	DESCRIPTION	OBS	■	□	■
	1m extension PVC cord 24V - Connectors M-C1/F-C2	-	<b>FY01-PVC</b>	<b>FY01B-PVC</b>	-
	2m extension PVC cord 24V - Connectors M-C1/F-C2	-	<b>FY02-PVC</b>	<b>FY02B-PVC</b>	-
	5m extension PVC cord 24V - Connectors M-C1/F-C2	-	<b>FY05-PVC</b>	<b>FY05B-PVC</b>	-
	2 output connector PVC 24V - Connectors M-C1/F-C2	-	<b>FY2-PVC</b>	<b>FY2B-PVC</b>	-
	3 output connector PVC 24V - Connectors M-C1/F-C2	-	<b>FY3-PVC</b>	<b>FY3B-PVC</b>	-
	230V -> 24V transformer with Octopus connector	10W max.	<b>FYPRTR9</b>	<b>FYPRTR9B</b>	-
	Transformer 230V / 24V with Octopus connectors	100W	-	<b>PRTR100W</b>	-
	Collector 24V PVC L: 80cm - 4 sockets spacing 20cm	-	<b>FY024</b>	<b>FY024-B</b>	-

# OCTOPLUS by Blachere®

tech 12V



DIAGRAM / PICTURE	DESCRIPTION	OBS	■	□	■
	T connector Octopus Tech	-	<b>FT-T1</b>	<b>FT-T1B</b>	-
	Octopus Tech extension - 50 cm	-	<b>FT-R05</b>	<b>FT-R05B</b>	-
	Octopus Tech extension - 1 m	-	<b>FT-R1</b>	<b>FT-R1B</b>	-
	Octopus Tech extension - 2 m	-	<b>FT-R2</b>	<b>FT-R2B</b>	-
	3 outputs Octopus Tech collector	-	<b>FT-C3</b>	<b>FT-C3B</b>	-
	12V/40W transformer	-	-	<b>FT-TR40</b>	-
	12V/100W transformer	-	<b>FT-TR100</b>	-	-
	12V/200W transformer	-	<b>FT-TR200</b>	-	-
	12V/50W amplifier/transformer	-	-	<b>FT-TRAS50</b>	-
	12V/50W amplifier/transformer	-	-	<b>FT-TRC50</b>	-
	2-way PVC connector	-	-	<b>FT-Y30</b>	-
	End-caps plug Octopus Tech	set of 5	<b>FT-B</b>	<b>FT-BB</b>	-

# FIL LUMIÈRE® accessories

## ELECTRICAL ACCESSORIES fil lumière platinum ø 12mm

\*The kit includes : 1 rubber power lead of 1m with plug and polarized connector + integrated AC/DC, bridge rectifier, 1 power lead spin, 1 full spin, 1 pot of glue and 1 end cap.



**NLC95-12**  
Fil lumière®\* power cord kit

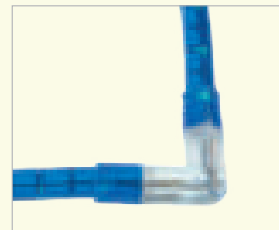

**NLC51L-12**  
Glueable L connector



**NLC92-12**  
Standardized glueable central "spins"



**NLC54-12**  
Glueable insulation end cap

## FIXING ACCESSORIES for fil lumière®



**NLC56**  
x 100



**NLC59**



**NLC61**  
Pot of glue PVC 250ml

## REPAIR KIT\* led platinum ø 12mm - 230V - IP55

REFERENCES	◆	COLOURS	TYPES	OTHER PRODUCTS INCLUDED IN THE KIT
NLKL01-12	10m of fil lumière®	○	(NML41)	2 power leads, glue, 10 connectors, 5 end caps
NLKL02-12	10m of fil lumière®	●	(NML42)	2 power leads, glue, 10 connectors, 5 end caps
NLKL06-12	10m of fil lumière®	●	(NML46)	2 power leads, glue, 10 connectors, 5 end caps
NLKL01W12	10m of fil lumière®	●	(NML41W)	2 power leads, glue, 10 connectors, 5 end caps

\* for Blachere Illumination motifs only

# FIXING ACCESSORIES for motifs and connexion housing

DIAGRAM / PICTURES	DESCRIPTIONS	REFERENCES
	Heart shape eye for ø 4mm cable set of 10	<b>D001</b>
	Heart shape eye for ø 6mm cable set of 10	<b>D011</b>
	Cable gripper for ø 4mm cable set of 10	<b>D002</b>
	Cable gripper for ø 6mm cable set of 10	<b>D012</b>
	Steel cable ø 4mm - 100m roll	<b>D005</b>
	Steel cable ø 6mm - 100m roll	<b>D006</b>
	Steel cable ø 4mm with PVC sheath ø 6mm 100m roll	<b>D015</b>
	Steel cable ø 6mm with PVC sheath ø 8mm 100m roll	<b>D016</b>
	Wall mount for GOBO projector 10 mm diameter holes	<b>PRM-GOBO1</b>
	Pole mount for GOBO projector 10 mm diameter holes	<b>PRP-GOBO1</b>

DIAGRAM / PICTURES	DESCRIPTIONS	REFERENCES
	Transverse unit for fastening to pole for ø 11mm cable pair	<b>MA011</b>
	Eyebolt L : 150mm set of 2pcs	<b>D033</b>
	Galvanized steel shackle ø 10mm	<b>MA002</b>
	Mixed stretcher unit - M10 L : 22 to 30cm	<b>D004</b>
	Ø 6mm Snap hook WLL 80kg	<b>DOM7T</b>
	safety sling L : 60cm WLL : 70kg	<b>D026</b>
	Differential circuit-breaker equipped with a waterproof power plug. (for poles) Note : box subject to modification according to availability	<b>C001</b>

# FIXING ACCESSORIES

for pole mounts

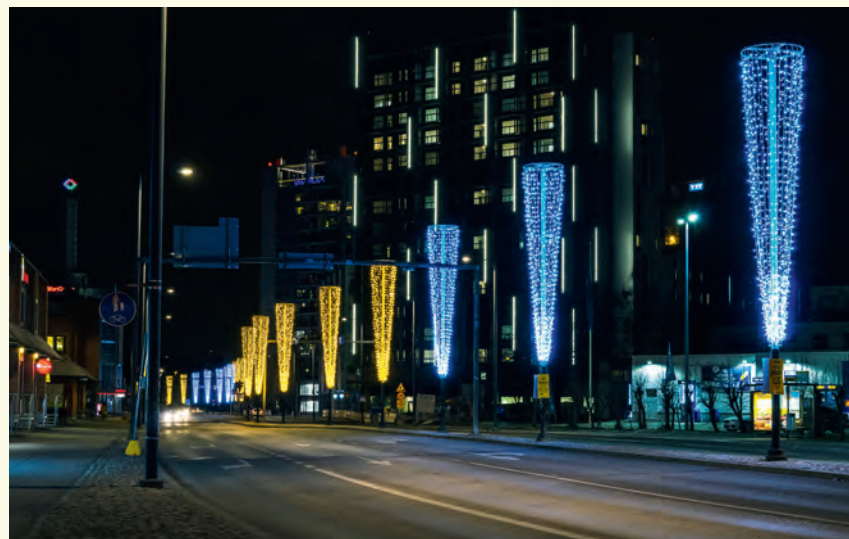

**INVERTED CONES**  
1 PIX03 (up)  
1 PIX04-2 (down)  
2 curtains H : 5m



**CYLINDER**  
2 PIX03  
2 curtains H : 5m



**CHRISTMAS TREE**  
1 PIX04-2 (up)  
1 PIX02 (down)  
1 curtain H : 3m



**FREE COMPOSITION**  
2 PIX03  
2 FL74WBF+  
1 FL900E

## CIRCULAR brackets

Put together low-price 3D decorations on your columns with our circular brackets (inner diameter adjustable).

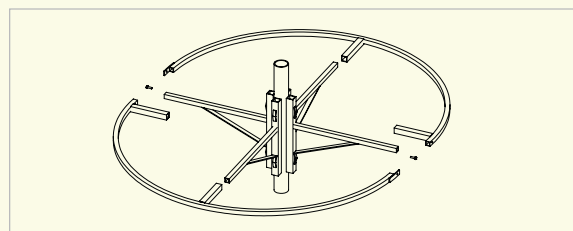

**PIX02 / PIX03**  
Circular bracket for assembling your 3D decorations  
Inner diameter adjustable

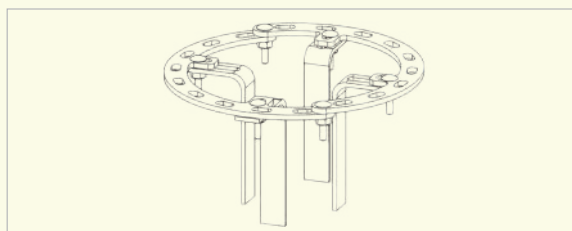

**PIX04-2**  
Circular bracket for assembling your 3D decorations  
Inner diameter adjustable

REFERENCES	ø	PERIMETER	ø POLE	USABLE WITH
PIX04-2	25 cm	0,80 m	60 à 120 mm	curtains
PIX02	60 cm	1,90 m	60 à 200 mm	curtains
PIX03	130 cm	4,00 m	60 à 200 mm	curtains

# FIXING ACCESSORIES

for suspensions

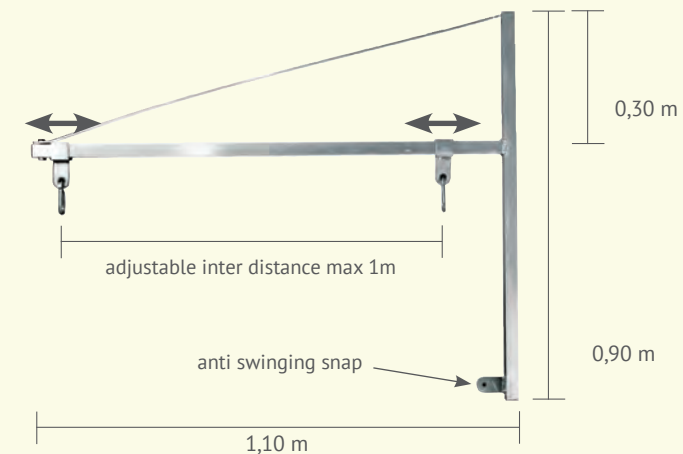

**PIX01**  
Horizontal bracket  
H: 0,90 m - L: 1,10 m  
Inter distance max: 1,00 m  
Load max: 25 kg

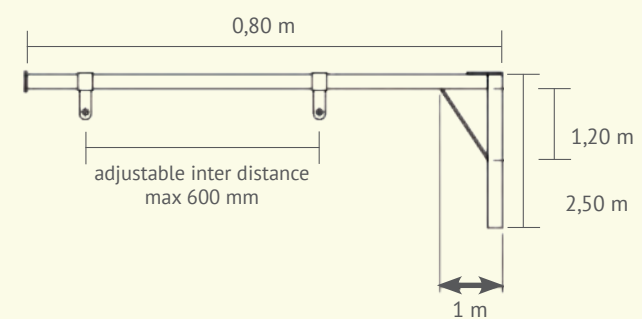

**PIXECO**  
Horizontal bracket  
H: 0,25 m - L: 0,80 m  
Inter distance max: 600 mm  
Load max: 10 kg

## FIXING ACCESSORIES for suspensions

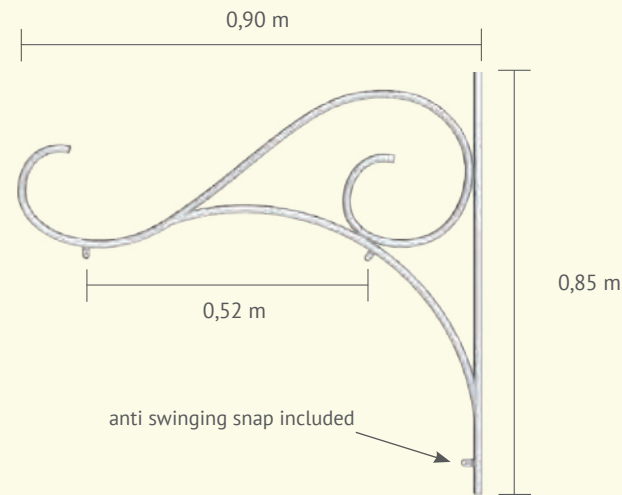
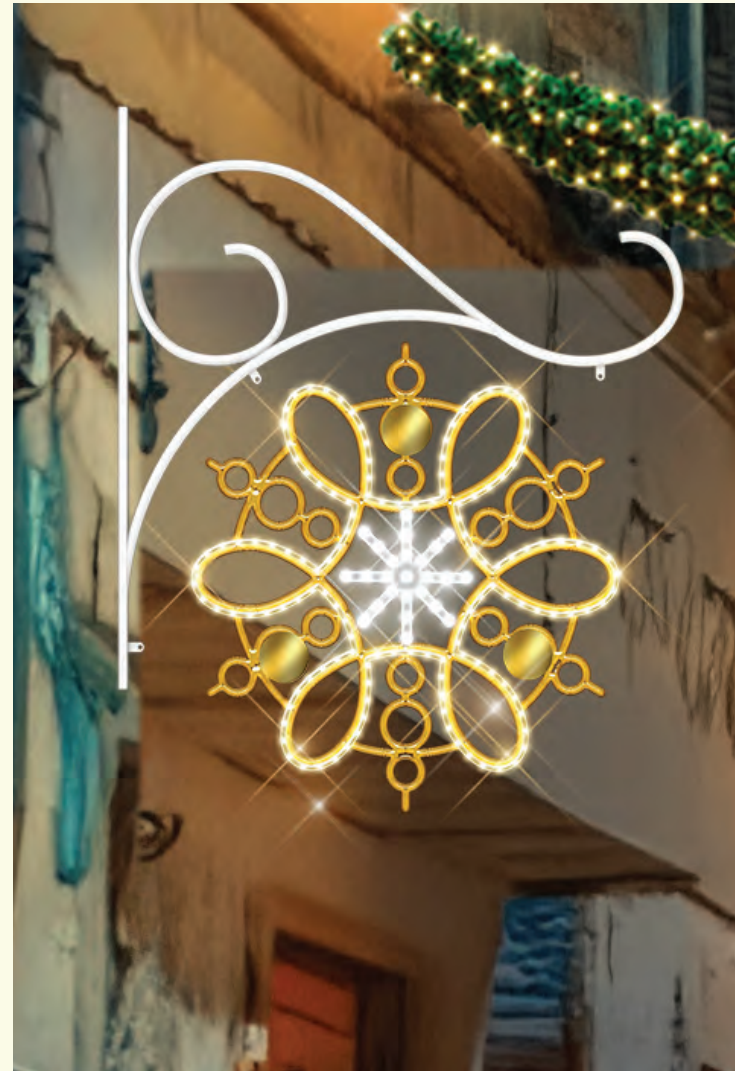

**PIX05B**  
Horizontal bracket  
White lacquered  
H: 0,85 m - L: 0,90 m  
Inter distance max: 0,52 m  
Load max : 30 kg

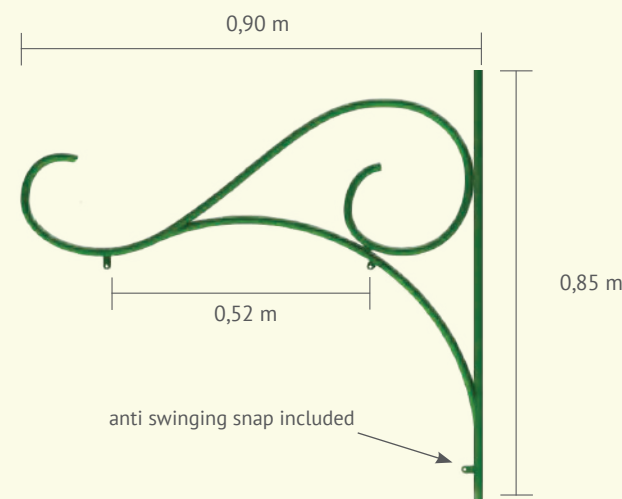

**PIX05**  
Horizontal bracket  
Green lacquered  
H: 0,85 m - L: 0,90 m  
Inter distance max: 0,52 m  
Load max : 30 kg

## FIXING ACCESSORIES for motifs

Each fastening must be individually strapped twice (see diagram). For motifs exceeding a height of 3.5m, it is essential to use three fasteners per motif.

**D007**  
Stapping box including 1 cutting pliers and 1 stapping pliers.

**D008**  
Stainless steel strap  
Roll of 50m, thick-ness : 0,7mm

**D009**  
Staple-clip for steel strapset of 100

**D0010**  
Black protection strip for Stainless steel strap  
L: 10 ml / 10 mm

**FYS060N**  
Fixing of decorations on masts.  
Black strap: l: 15mm, L: 600mm, 8cm mini ratchet, LC 50 daN  
This strap is reusable and does not slip

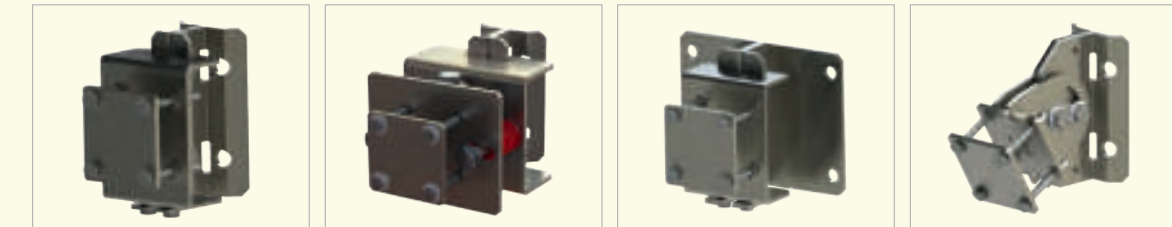

**PIX01**  
Fastening device for pole  
Obs : sold by pair  
RAL7032

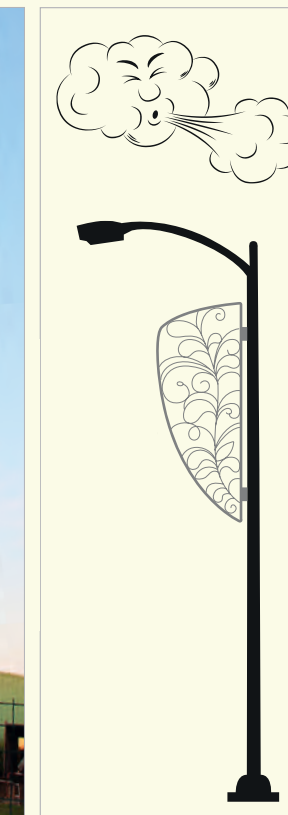

**PIX01P**  
Strengthened fastening devices for poles (wind area 3)  
Obs : sold by pair  
RAL7032

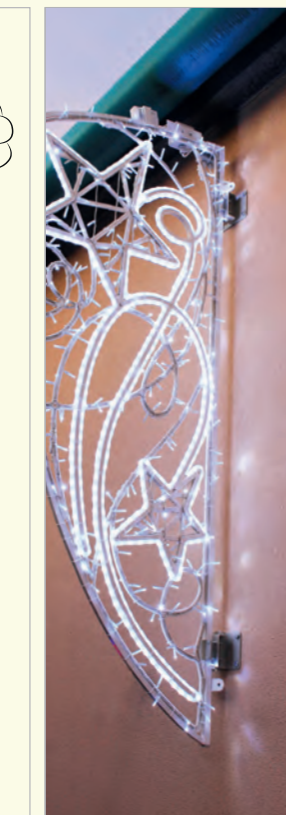

**PIX01M**  
Fastening devices for facades  
Obs : sold by pair  
RAL7032

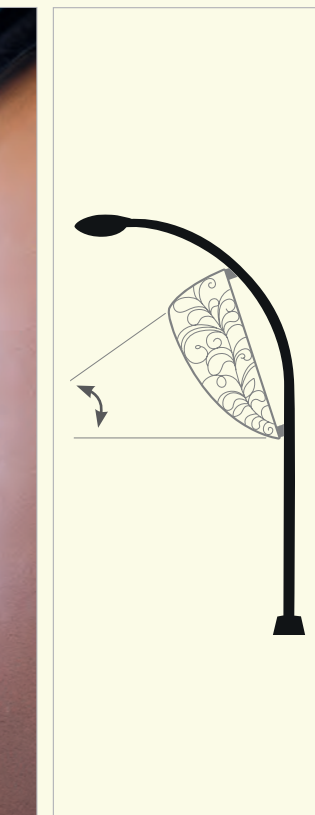

**PIX01MC**  
Fastening devices for curved pole.  
Obs : sold by pair  
RAL7032

# SOLAR ACCESSORIES

**A new roundabout to decorate but no power supply?**

Or looking to illuminate a street on your own with zero carbon emissions?

**Choose our solar solutions.**

Discreet panels, with an integrated autonomous and programmable system (switch-on and switch-off times).

Adapted light decorations, 24V string lights, and more. We offer you a **complete range that is 100% self-powered.**

All you need is sunshine!

Consult our advisory teams for a personalised analysis!



## SOLAR KIT SELF-POWERED

### KITSOL

- Kit containing a solar panel with high-performance monocrystalline cells.
- Gel batteries for 2400 cycles with discharge
- Power regulator and discharge protection
- 24V or 230V output easily switched by rotary selector
- Can be fixed to the floor

### PRODUCT DETAILS

- 50% battery consumption after 12 hours
- Low-power prevents battery damage.
- Easy to move thanks to flexible rubber wheels with high abrasion resistance
- Maintenance-free and easy to install



## SOLAR KIT POLE

### PIXSOL2

- 20W panel power
- 7.2W power output
- DAILY PROGRAMMER: selection of the days and times lighting set is switched on
- 8 to 10 hours of sunshine required for 7 hours of lighting set operation

### COMPATIBLE PRODUCTS

- String lights 1 x FL502...
- String lights 1 x 501CW
- String lights 1 x 501W
- String lights 1 x G-FL920LU
- Sphere 1 x G-FL920M
- Bulb 1 x G-FL930BB
- Kit 1 x PRJA et PRJA-W



## SOLAR KIT LED PROJECTOR

### PIXSOL3

- 20W panel power
- 4W power output
- DAILY PROGRAMMER: selection of the days and times lighting set is switched on
- 8 to 10 hours of sunshine required for 7 hours of lighting set operation

### COMPATIBLE REFERENCES

- PRJA or PRJA-W



# BALLASTING

*illuminations in flexiprint*

Dress up your blocks as pretty gifts! Use our magical gifts to hide the concrete blocks in your decorations!

Depending on the features of your decoration, put together your own ballast kit and wrap your gift (size & colour).



**KPL0020 - Concrete ballast block**  
Set of 20kg suitable for flexiprint material



**KPL0040 - Concrete ballast block**  
Set of 40kg suitable for flexiprint material



**KPL0100B - Concrete ballast block**  
Set of 100kg suitable for flexiprint material

Wrapping steps (clips are supplied)

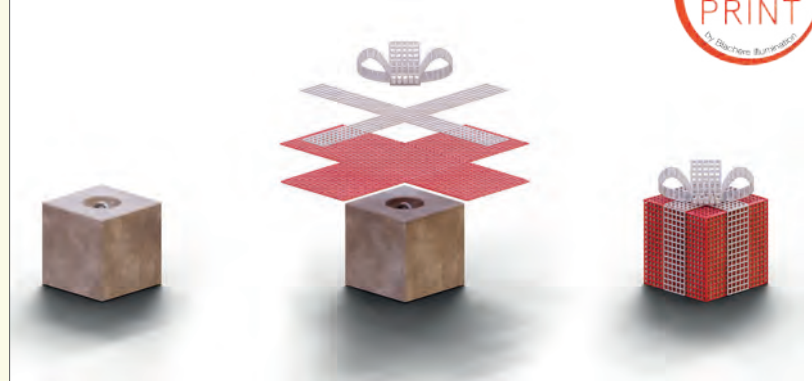

Example : KPL0100B + KFLEXCA1

**1. Choose your block :**

REFERENCES	DESIGNATION	DIMENSIONS
KPL0020	Concrete block - 20kg	0,20 x 0,20 x 0,20 m
KPL0040	Concrete block - 40kg	0,30 x 0,30 x 0,20 m
KPL0100B	Concrete block - 100kg	0,37 x 0,37 x 0,37 m

**2. Choose your cover :**

REFERENCES	DESIGNATION	DIMENSIONS	COLOURS
KFLEXCA2	Block cover - PM	0,20 x 0,20 x 0,20 m	BLUE / white
KFLEXCA5	Block cover - MM	0,30 x 0,30 x 0,20 m	BLUE / white
KFLEXCA8	Block cover - GM	0,37 x 0,37 x 0,37 m	BLUE / white
KFLEXCA1	Block cover - PM	0,20 x 0,20 x 0,20 m	RED / white
KFLEXCA4	Block cover - MM	0,30 x 0,30 x 0,20 m	RED / white
KFLEXCA7	Block cover - GM	0,37 x 0,37 x 0,37 m	RED / white
KFLEXCA3	Block cover - PM	0,20 x 0,20 x 0,20 m	GREEN / white
KFLEXCA6	Block cover - MM	0,30 x 0,30 x 0,20 m	GREEN / white
KFLEXCA9	Block cover - GM	0,37 x 0,37 x 0,37 m	GREEN / white

\* Enter the reference for the decoration + the block + the cover

GX345L +  
. 3 x KPL0100B + 3 x KFLEXCA8 +  
. 3 x KPL0040 + 3 x KFLEXCA6



# SCENOGRAPHY / DECORATIONS

accessories



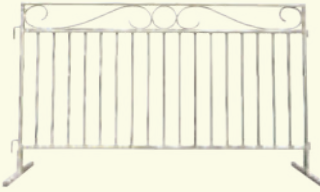

DIAGRAM / PICTURES	DESCRIPTION	REFERENCES
	To complement your decorations, we can provide you with our real fir trees sustainably cultivated and processed with flake finish based on fireproof natural cellulose fibre. Contact our sales department and choose your colours and finish.	
	Mounting base lacquered in gold for 3D motif ø : 800mm	<b>PLA800OR</b>
	Mounting base lacquered in gold for 3D motif ø : 1200mm	<b>PLA1200OR</b>

DIAGRAM / PICTURES	DESCRIPTION	REFERENCES
		
	Opera barrier H : 1,20m L : 2,00m	<b>BARR01</b>
	White pine barrier H : 0,80m L : 1,80m	<b>GP506-B</b>

# SCENOGRAPHY / DECORATIONS

accessories

DIAGRAM / PICTURES	DESCRIPTION	REFERENCES
	Square Carpet Blue 3m x 3m	<b>GPC300B</b>
	Round Carpet Blue ø : 3m	<b>GPR300B</b>
	Square Carpet Red 3m x 3m	<b>GPC300R</b>
	Round Carpet Red ø : 3m	<b>GPR300R</b>

DIAGRAM / PICTURES	DESCRIPTION	REFERENCES
	White cotton carpet roll 30m x 2,6m	<b>GP500</b>
	Red carpet roll 10m x 2m	<b>GP510R</b>
	Red - ø 140mm Set of 16	<b>B14-1</b>
	Gold - ø 140mm Set of 16	<b>B14-2</b>
	Red - ø 200mm Set of 9	<b>B20-1</b>
	Gold - ø 200mm Set of 9	<b>B20-2</b>
	Red - ø 250mm Set of 2	<b>B28-1</b>
	Gold - ø 250mm Set of 2	<b>B28-2</b>

# INDEX

352	225	29CBFX	205	530WWF	177	D011	283	FL203-FX	211	FL72F+	201	FT-BB	281	FY023-B+	278	FYPRTR9	280	GR100CN	191	GX154LW	53	GX308L	34
354	225	29CW-B	207	558-FX	243	D012	283	FL203B-FX	211	FL72W+	203	FT-C3B	281	FY024	280	FYPRTR9B	280	GR112C	191	GX155LW	54	GX327L	58
414	237	29CWBFX	205	558W-FX	243	D015	283	FL203P-FX	211	FL72WBF+	201	FT-IC256B	219	FY024-B	280	FYS060N	287	GR112CN	191	GX156LW	58	GX327LW	58
508	183	29SG	209	560-F	181	D016	283	FL203R-FX	211	FL72WF+	201	FT-JL256	199	FY02B-PVC	280	FYS0DOW	268	GR113C	191	GX159L	42	GX333L	32
20C-B	207	29WSG	209	600W	189	D026	283	FL203W-FX	211	FL74-B+	203	FT-R05	281	FY030-B+	278	FYTB+	278	GR113CN	191	GX160L	48	GX344L	63
20CBFX	205	330BWWF	221	600WWF	189	D033	283	FL220C	214	FL74+	203	FT-R05B	281	FY030+	278	FYT+	278	GR1C	191	GX163L	33	GX344LW	63
20CBLFX	205	352-FX	225	601WIC	233	DOM7T	283	FL224C	214	FL74BF+	201	FT-R1	281	FY030M	249	G-FL900	251	GR1CN	191	GX164L	43	GX345L	31
20CRFX	205	352B-FX	225	602WIC	233	ECOXR20-B	213	FL390-B+	223	FL74F+	201	FT-R1B	281	FY031-B+	278	G-FL900WW	251	GR2C	191	GX172LW	46	GX346L	28
20CW-B	207	352R-FX	225	650W	189	ECOXR20W-B	213	FL390BF+	223	FL74W-B+	203	FT-R2	281	FY031+	278	G-FL920LU	252	GX048LW	130	GX173L	60	GX347L	30
20CWBFX	205	352W	225	802W-F	217	ECOXR20W-F	213	FL390W-B+	223	FL74W+	203	FT-R2B	281	FY03B22	279	G-FL920M	253	GX070LR	53	GX173LW	60	GX348L	29
20SG	209	352W-FX	225	803W-F	217	ECOXR216W	215	FL390WBF+	223	FL74WBF+	201	FT-ST128	173	FY03B22-B	279	G-FL930BB	255	GX079L	49	GX184L	50	GX349L	30
20WSG	209	353C	225	804WSF	217	ECOXR22-B	213	FL502-FX	185	FL74WF+	201	FT-ST128B	173	FY041A-B+	278	G-MONT+	261	GX081LW-2	74	GX184LW	50	GX350LW	47
21CBFX	205	353CW	225	950-FX	259	ECOXR22W-B	213	FL502B-FX	185	FL75-B+	203	FT-ST64	173	FY041A+	278	G-MONTW+	261	GX082LW	74	GX185LW	61	GX354L	62
21CWBFX	205	354-FX	225	950W-FX	259	ECOXR24-B	213	FL502R-FX	185	FL75+	203	FT-T1	281	FY043A-B+	278	G-SPHER+	261	GX083LW	74	GX193L	22	GX354LW	62
22C-B	207	354W	225	B14-1	293	ECOXR24W-B	213	FL502W-FX	185	FL75BF+	201	FT-T1B	281	FY043A+	278	G-SPHERE	261	GX086L	44	GX194L	39	GX355LW	62
22CBFX	205	354W-FX	225	B14-2	293	ECOXR24W-F	213	FL525RGB	175	FL75F+	201	FT-TR100	281	FY04BRIN	249	G-SPHERW+	261	GX086L-A	44	GX200L	159	GX356L	28
22CW-B	207	355-FX	227	B20-1	293	ECOXR25-B	213	FL555C	194	FL75W-B+	203	FT-TR200	281	FY04FXL	258	G-STAR	261	GX087L	33	GX205L	49	GX357L	31
22CWBFX	205	355W-FX	227	B20-2	293	ECOXR25W-B	213	FL590-B+	179	FL75W+	203	FT-TR40	281	FY04W-PVC	257	G-STAR+	261	GX092L	36	GX206L	49	GX358L	40
22SG	209	414-FX	237	B28-1	293	ECOXR25W-F	213	FL590+	179	FL75WBF+	201	FT-TRASSO	173	FY05-PVC	280	G-STARW+	261	GX093L	36	GX244L	41	GX419L	22
22WSG	209	414W	237	B28-2	293	ECOXR29-B	213	FL590BF+	179	FL75WF+	201	FT-TRC50	173	FY05B-PVC	280	GP1-400	71	GX098L	45	GX245LW	47	GX420L	23
24C-B	207	414W-FX	237	BARR01	292	ECOXR29W-B	213	FL590BL+	179	FL79-B+	203	FT-Y30	281	FY07A	279	GP1-600	71	GX102LW	40	GX247L-A	41	GX421L	23
24CBFX	205	415WHP	235	BG50-1	264	ECOXR350F	229	FL590BLF+	179	FL79+	203	FXL055	258	FY08-B+	278	GP134L-W	197	GX103L	158	GX248LR	42	GX422L	23
24CBLFX	205	416WHP	187	BG50-2	264	ECOXR350WF	229	FL590F+	179	FL79BF+	201	FXL08-B22	258	FY08-B5+	278	GP134LWFX	197	GX103L-A	158	GX251L	67	GX423L	18
24CRFX	205	501CW	185	BG50-3	264	ECOXRSL3F	245	FL590R+	179	FL79F+	201	FXL085	258	FY08-BUK+	278	GP138L	231	GX105L	43	GX251LW	67	GX424L	19
24CW-B	207	501W	185	BG50-4	264	ECOXRSL3WF	245	FL590RF+	179	FL79W-B+	203	FXL920E	250	FY08-BW	278	GP139L-W	231	GX114LW	100	GX252L	51	GX425RGB	19
24CWBFX	205	508-B	183	BRIN180	249	ECOXRSL3WF	245	FL590W-B+	179	FL79W+	203	FXL920S	250	FY08-S+	278	GP158WF	71	GX116LW	130	GX252LW	51	GX426L	18
24SG	209	508B	183	BRIN180W	249	F080W-B	169	FL590W+	179	FL79WBF+	201	FY-MOUS	279	FY08-UK+	278	GP303W	195	GX117LW	130	GX253LW	67	GX427RGB	19
24WSG	209	508W	183	BRIN288	257	F160	169	FL590WBF+	179	FL79WF+	201	FY01-1+	278	FY08-W	278	GP304W	195	GX118DC	39	GX256LW	46	GX428DC	26
25C-B	207	508W-B	183	BRIN288W	257	F160-B	169	FL590WF+	179	FL900E	251	FY01-10+	278	FY08+	278	GP500	293	GX118L	43	GX257LW	46	GX428RGB	19
25CBFX	205	510-FX	183	BTX4	279	F160W	169	FL70-B+	203	FL900EM	251	FY01-10B+	278	FY1C+	278	GP506-B	292	GX119L	43	GX258L	47	GX429L	26
25CBLFX	205	510B-FX	183	BTX8	279	F160W-B	169	FL70+	203	FL900EW	251	FY01-1B+	278	FY1CB+	278	GP510R	293	GX132L	35	GX258LW	47	GX430L	27
25CRFX	205	510BW-FX	183	C001	283	F722-L	193	FL70BF+	201	FL900S	251	FY01-2+	278	FY2-PVC	280	GPC300B	293	GX133L	44	GX259LW	43	GX431L	27
25CW-B	207	510P-FX	183	D001	283	F732-L	193	FL70F+	201	FL900WW	251	FY01-2B+	278	FY230F2	279	GPC300R	293	GX145L	48	GX260L	37	GX432LR	54
25CWBFX	205	510R-FX	183	D002	283	FCL080A	247	FL70W-B+	203	FL920LU	252	FY01-3+	278	FY230F2-B	279	GPR300B	293	GX145L-A	48	GX260LW	37	GX432LW	54
25SG	209	510W-FX	183	D004	283	FCL080A-E	247	FL70W+	203	FL920M	253	FY01-3B+	278	FY230M1	279	GPR300R	293	GX146L	159	GX261LW	36	GX433L	23
25WSG	209	511-FX	183	D005	283	FCL080G	247	FL70WBF+	201	FL930A	256	FY01-5+	278	FY230M1-B	279	GR098C	191	GX147L	49	GX262LW	42	GX433L-UK	23
260-F	181	511B-FX	183	D006	283	FCL080G-E	247	FL70WF+	201	FL930A-E	247	FY01-5B+	278	FY2B-PVC	280	GR098CN	191	GX148L	34	GX263L	40	GX434L	22
29C-B	207	512-FX	183	D007	287	FIX01	287	FL72-B+	203	FL930BB	255	FY01-PVC	280	FY3-PVC	280	GR099C	191	GX149L	49	GX264LW	41	GX434L-UK	22
512C	183	D008	287	FIX01M	287	FL72+	203	FL930G-E	247	FY01B-PVC	280	FY3B-PVC	280	GR099CN	191	GX151L	38	GX265LW	33				
512CW	183	D009	287	FIX01MC	287	FL72BF+	201	FT-B	281	FY02-PVC	280	FYSP-DMX	265	GR100C	191	GX152L	38	GX266DC	61				
512W-FX	183	D010	287	FIX01P	287	FL72F+	201	FT-BB	281	FY023-B+	278	FYSS-DMX	265	GR100C-B	191	GX153L	35	GX267LW	41				

HLPRIJPMX	265	IPL191B	146	IPL300W	104	IPS264W	157	ITL101W	88	ITL310W	104	KFLEXCA3	290	NLS016	263	PRJA-W	268	SLED010W	64	TGL71LWW	126
IPL031W	98	IPL191R	146	IPL311	104	IPS280	157	ITL102W	88	ITL312	136	KFLEXCA4	290	NLC511-12	282	PRJP-03W+	269	SND017	64	TGL72LW	126
IPL042W	150	IPL191W	146	IPL311W	104	IPS280W	157	ITL113W	118	ITL312W	136	KFLEXCA5	290	NLC54-12	282	PRJP5-DMX	265	SND018	70	TGL72LWW	126
IPL070W	120	IPL199	136	IPL317R	96	IPS281W	157	ITL115W	152	ITL314	136	KFLEXCA6	290	NLC56	282	PRJPGOB03	270	SND019	69	TL311R	114
IPL075W	112	IPL199W	136	IPL318R	96	IPS289W	157	ITL118W	138	ITL314W	136	KFLEXCA7	290	NLC59	282	PRJR4-DMX	265	SND021	70	TL311W	114
IPL076W	120	IPL200	136	IPL319R	96	IPS290	157	ITL127W	138	ITL315	88	KFLEXCA8	290	NLC60	279	PRJR6-DMX	265	SND022	69	TL312R	114
IPL081W	120	IPL200W	136	IPL320R	96	ITGL100	100	ITL129	86	ITL316W	88	KFLEXCA9	290	NLC61	282	PRTR100W	280	S0CL42	48	TL312W	114
IPL082W	98	IPL201	136	IPL322	134	ITGL101W	100	ITL129W	86	ITL321R	96	KITSOL	288	NLC92-12	282	PRTR24N	268	S0CL43	37	TL347W	130
IPL087W	112	IPL201W	136	IPL323W	134	ITGL104	124	ITL130	86	ITL327W	112	KPLO020	290	NLC95-12	282	PRTR24V	247	S0CL47	38	TL356W	118
IPL094W	150	IPL202W	96	IPL324W	112	ITGL104W	124	ITL130W	86	ITL328W	108	KPLO040	290	NLEDU51	263	PRTR24VI	247	S0CLGX81	77	TL358W	118
IPL110	120	IPL203W	96	IPL325W	112	ITGL105	124	ITL161W	84	ITL331W	108	KPLO100B	290	NLEDU51W	263	PRX10RGB	175	S0CLGX82	77	TL359W	118
IPL114W	118	IPL228B	150	IPL326W	112	ITGL105W	124	ITL165	88	ITL332W	108	LDL11-B22	193	NLEDU52	263	SC032RGB	18	S0CLGX83	77	TL360W	118
IPL115W	112	IPL228W	150	IPL328W	108	ITGL111	128	ITL165W	98	ITL333W	108	LDL11-E27	193	NLEDU53	263	SL005W	60	SV1001	68	TSL2	244
IPL117W	150	IPL230	84	IPL329W	108	ITGL111W	128	ITL191B	148	ITL336W	84	LDL11W-B2	193	NLEDU54	263	SL012	59	SV1001W	68	TSL2W	244
IPL118W	138	IPL230W	84	IPL330W	108	ITGL112	152	ITL191W	148	ITL338	82	LDL11W-E2	193	NLEDU56	263	SL012W	59	SV1201-P	68	TSL3FX	244
IPL122	138	IPL231W	96	IPL332W	114	ITGL112W	152	ITL218W	96	ITL338W	82	LDL12-B22	193	NLEDWW	263	SL013	59	SV1201W-P	68	TSL3WFX	244
IPL126	138	IPL257	144	IPL333W	108	ITGL117R	128	ITL226W	96	ITL344B	94	LDL12-E27	193	NLKL01-12	282	SL013W	59	SV301	68	TSL4WWF	239
IPL126W																					

# Blachere INTERNATIONAL



## BLACHERE ILLUMINATION S.A.S

22 Allée des Bourguignons  
84400 Apt - France  
tél : +33 (0) 490 742 095  
fax : +33 (0) 490 747 367  
sales@blachere-illumination.com  
**blachere-illumination.com**

### Géraldine

tél : +33 (0) 490 747 323  
geraldine@blachere-illumination.com

### Léa

tél : +33 (0) 490 747 642  
l.alves@blachere-illumination.com

### Marion

tél : +33 (0) 490 747 330  
marion@blachere-illumination.com

### Sandrine

tél : +33 (0) 490 747 396  
s.cerda@blachere-illumination.com

### Marie

tél : +33 (0) 490 747 044  
marie@blachere-illumination.com

### Cathy

tél : +33 (0) 490 747 325  
cathy@blachere-illumination.com

## AFRIQUE/AFRICA

Blachere Illumination Afrique  
Rue du Caire - Route de M'Saken,  
4081 Zaouiet Sousse  
tel : +216 73 386 601  
email : gregory.roux@blachere-factory.com  
fax : +216 73 386 650

## ASIE PACIFIQUE/ASIA PACIFIC

Blachere Illumination Asia Pacific  
Unit B, 17/F., United Centre, 95 Queensway,  
Admiralty, Hong Kong  
email : hkoffice@blachere-illumination.com

## AUTRICHE/AUSTRIA & ALLEMAGNE/GERMANY

Blachere Illumination GmbH  
Krenglbacher Straße 7- 4631 Krenglbach  
tel : +43 (0) 7249 46400 - 0  
email : office@blachere.at

## BELGIQUE/BELGIUM

Blachere Illumination Belgique  
Rue de Hermée 225, 4040 Herstal  
tel : +32 4 275 02 81  
email : info@blachere-illumination.be

## BRÉSIL/BRASIL

Blachere Iluminação Brasil  
Estrada do Zilo, 1519 - Distrito Industrial,  
Araçariguama - São Paulo 18147-000  
tel : +55 11 99512-6734  
email : sergio.cmolina@cmaise.com.br

## CANADA/CANADA

Blachere Illumination Canada  
3400 14th Avenue, Unit 18, Markham, Ontario L3R  
0H7  
tel : 905-475-6553  
email : info@blachere-illumination.ca  
Web : www.blachere-illumination.ca

## COLOMBIE/COLOMBIA

Blachere - City Lights  
Carrera 33 N. 19-26, Bogotá  
tel : 576 016 466 000  
email : comercial@blachere.co - jklahr@blachere.co

## CROATIE/CROATIA

Blachere Illumination Croatia (Blachere Illumination  
- Gospodari svjetla)  
Medsave 4B, 10430 Samobor  
tel : +385 1 8877 660  
email : info@gospodarisvjetla.hr  
Web : www.gospodarisvjetla.hr

## DANEMARK/DENMARK

Blachere Illumination - JADA GROUP APS  
Norgesvej 2, 6230 Rødekro  
tel : +45 70 20 00 03  
email : info@jadagroup.dk

## ESPAGNE/SPAIN

Blachere Iluminación España s.a  
Calle Corazón de María, 70-8E, 28002 Madrid  
tel : +34 91 388 28 77  
email : info@blachere-illumination.es

## ÉTATS-UNIS/USA

Blachere Illumination USA Inc.  
PO Box 41, 4198 State Highway 14 W, Christopher, IL 62822  
tel : +1 618-724-1500  
email : info@blachere-illumination.us  
fax : +1 618-724-4500  
Web : https://blachere-illumination.com/en/blachere-illumination-usa

## EUROPE CENTRALE/CENTRAL EUROPE

Blachere Illumination Central Europe  
Karadžičova 8/A, Bratislava 821 08  
tel : 421918428040  
email : info@blachere-illumination.sk

## FINLANDE/FINLAND

Blachere Illumination Finland - Lohikari  
Ruoholahdenkatu 24, 00180 Helsinki  
tel : +358 9 565 7750  
email : lohikari@lohikari.fi  
Web : www.lohikari.fi

## HONGRIE/HUNGARY

Blachere Illumination Hungary  
H-2142, Nagytarcsa, Csonka János út 4, K bâtiment  
tel : +36 70 389 1475  
email : info@blachere-illumination.hu

## ITALIE/ITALY

Blachere Illumination Italia - Lumiworks Srl  
Via Euippa 22, 73100 Lecce  
tel : 393760563212  
email : info@lumiworks.it

## MAROC/MOROCCO

Blachere Illumination Maroc SARL - Sapi Centre,  
1377 Parc Industriel Sapino, Nouaceur - Maroc  
tel : +212 5 22 01 48 79  
email : info@blachere-illumination.ma

## MEXIQUE/MEXICO

Blachere Iluminación México - Lucas Feliz  
3 Oriente No. 416 Centro. 74200 Atlixco, Puebla  
tel : +52 244 44 51 281  
email : contacto@blachere.com.mx  
Web : https://blachere.com.mx

## MOYEN-ORIENT/MIDDLE EAST

Blachere Illumination Middle East  
FAB Property Management Buildings  
Building 22 Warehouse 3 DIP 1  
tel : +971 4 254 8856  
email : m.soltay@blachere-illumination.ae

## NORVÈGE/NORWAY

Blachere Illumination Norway - Eurosign  
Stanseveien 21, 0975 Oslo  
tel : +47 23 00 85 00  
email : salg@eurosign.no

## PAYS-BAS/NETHERLANDS

Blachere Illumination Netherlands - Avontuur  
Blokdijk 3 - 1608 HH Wijdenes  
tel : +31 229 50 12 22  
email : info@avontuur.net

## POLOGNE/POLAND

Blachere Illumination Polska  
Jasna 39 - 86-070 Czemlewo  
tel : 48668318492  
email : info@blachere-illumination.pl

## PORTUGAL/PORTUGAL

Blachere illumination - Design Studio  
Rua Pedro Nunes  
IPN Aceleradora Edifício D - Sala 1.15  
3030-199 Coimbra, Portugal  
design@blachere-illumination.pt  
Tel: 00351 239 134 384

## RÉP. TCHÈQUE/CZECH REPUBLIC

Blachere Illumination Czech Republic  
Ostrá Horka I/511 - 760 01 Zlín  
tel : 420602227226  
email : pesek@blachere-illuminations.cz

## ROUMANIE/ROMANIA

Blachere Illumination Romania  
Cluj Napoca, Str. Anatole France, nr. 22, et. 2  
birou 2, Judetul Cluj, cod postal 400463  
tel : +40 75 705 08 66  
email : office@blachere-illumination.ro  
fax : +40 31 845 13 73

## ROYAUME-UNI/UK

Blachere Illumination UK Ltd  
Baird Road, Eastfield Industrial Estate,  
Fife, KY7 4PA  
tel : +44 (0)1337 832 910  
email : sales@blachere-illumination.co.uk  
Web : www.blachere-illumination.co.uk

## SUÈDE/SWEDEN

Blachere Sweden AB  
C/O Arena Sergel, Malmskillnadsgatan 36  
11157 Stockholm  
tel : +46 (0)72 601 66 46  
email : info@blachere-illumination.se

## SUISSE/SWITZERLAND

Blachere Illumination Swiss SA  
Rue du Châtelard 18 1400 Yverdon-les-Bains  
tel : +41 21 886 30 80  
email : office@blachere-illumination.ch  
Web : www.blachere-illumination.ch

## TURQUIE/TURKEY

Blachere Illumination Aydınlatma  
Hasanpaşa Mh. Lavanta Sk. Polat İş Merk.26/3,  
Kadıköy-İstanbul  
tel : +90 532 660 69 23  
email : msoltay@blachere-illumination.com.tr

# Blachere FRANCE

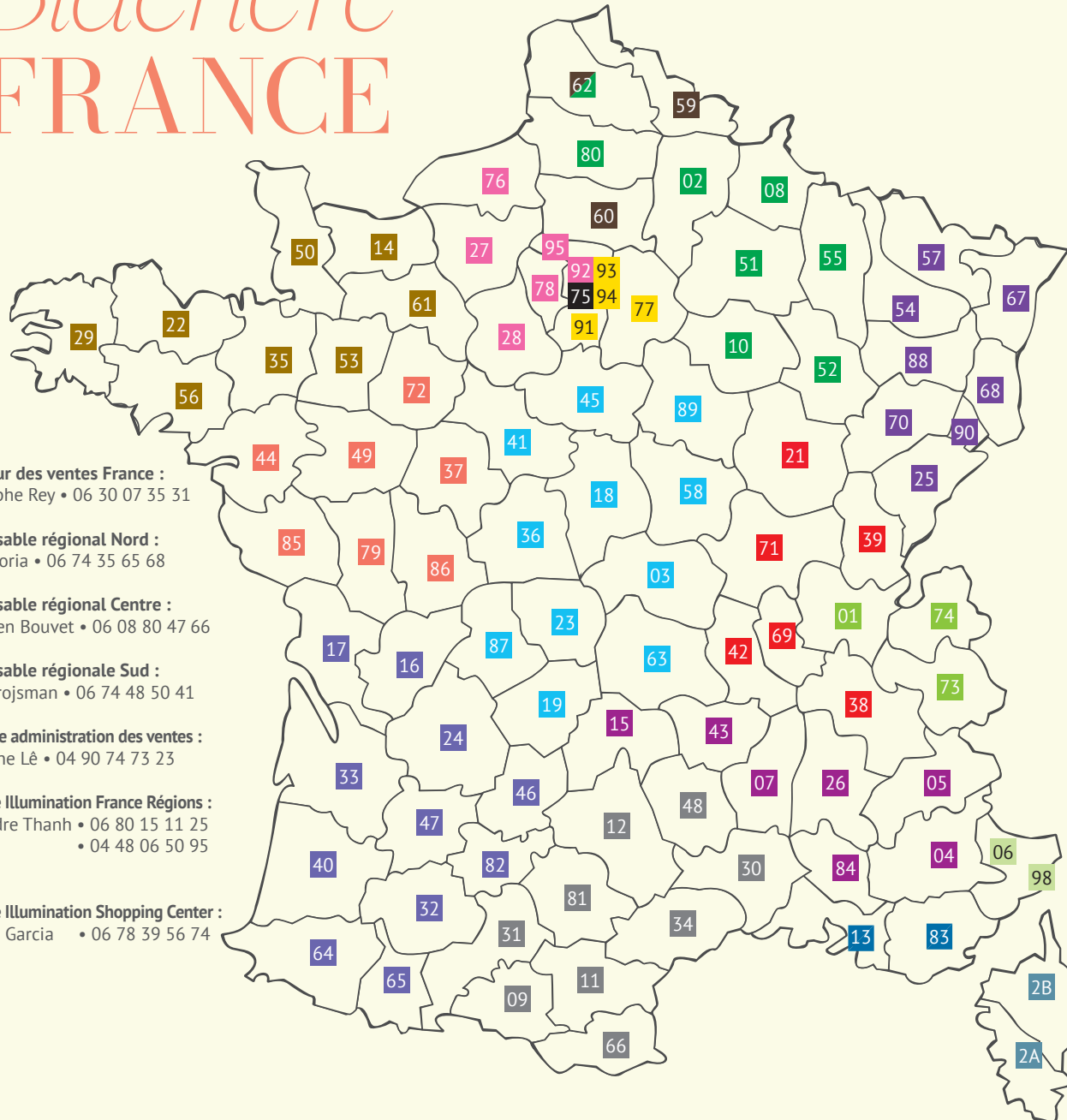

- **Directeur des ventes France :**  
Christophe Rey • 06 30 07 35 31
  
- **Responsable régional Nord :**  
Joao Vitoria • 06 74 35 65 68
  
- **Responsable régional Centre :**  
Sébastien Bouvet • 06 08 80 47 66
  
- **Responsable régionale Sud :**  
Aude Grojsman • 06 74 48 50 41
  
- **Directrice administration des ventes :**  
Géraldine Lê • 04 90 74 73 23
  
- **Blachere Illumination France Régions :**  
Alexandre Thanh • 06 80 15 11 25  
• 04 48 06 50 95
  
- **Blachere Illumination Shopping Center :**  
Corinne Garcia • 06 78 39 56 74

- Paris intramuros**  
Cédric Parcineau • 01 42 77 66 15 / 07 77 26 37 76  
Assistante, Sandrine Sarrazin • 04 90 74 70 45
- Île-de-France Est**  
Sophie Duquesnoy • 06 08 00 57 52  
Assistante, Sarah Galizzi • 04 90 74 73 61
- Île-de-France Ouest**  
Véronique René • 06 08 80 47 65  
Assistante, Sarah Galizzi • 04 90 74 73 61
- Nord - Picardie**  
Barbara Gheysens • 06 31 59 64 07  
Assistante, Anaïs Truphémus • 04 90 74 73 94
- Champagne - Ardennes**  
Matthieu Mairie • 06 79 47 06 26  
Assistante, Anaïs Truphémus • 04 90 74 73 94
- Alsace - Lorraine**  
Olivier Radreaux • 06 07 67 39 46  
Assistant, Vincent Vicari • 04 90 74 70 47
- Savoie - Haute Savoie**  
Maëva Rigoureux • 06 42 56 43 70  
Assistante, Nadège David • 04 90 74 73 60
- Rhône - Sud Bourgogne - Jura - Isère - Loire**  
Soizic De Vanel • 06 70 12 41 62  
Assistante, Delphine Borel • 04 90 74 96 24
- Bourgogne - Centre - Limousin - Auvergne**  
Maxime Bavouzet • 06 78 52 33 82  
Assistante, Marianne Fabi • 04 90 74 73 90
- Bouches-du-Rhône - Var**  
Xavier Le Perven • 06 84 02 80 04  
Assistante, Delphine Borel • 04 90 74 96 24
- Côte d'Azur - Monaco**  
Jérôme Falin • 06 37 62 41 21  
Assistante, Stéphanie Imbert • 04 90 74 96 22
- Vaucluse - Ardèche - Cantal - Haute Loire - Drôme**  
Delphine Ha • 06 48 79 99 62  
Assistante Delphine Borel • 04 90 74 96 24
- Occitanie - Pyrénées - Méditerranée - Aveyron**  
Justine Gaussen • 06 47 04 59 85  
Assistante, Sandrine Sarrazin • 04 90 74 70 45
- Sud-Ouest**  
Nicolas Montenon • 07 85 88 19 50  
Assistante, Sandrine Sarrazin • 04 90 74 70 45
- Pays de Loire - Poitou**  
Sophie Pintiaux • 06 85 23 77 43  
Assistante, Stéphanie Imbert • 04 90 74 96 22
- Bretagne - Basse Normandie**  
Ludovic Martin • 06 30 07 35 09  
Assistante, Nadège David • 04 90 74 73 60
- Corse**  
M. Gabbiani Fabrice • 06 29 31 51 19  
Nadège Dauberte • 04 90 74 73 63





Blachere Illumination Central Europe  
Karadžičova 8/A, Bratislava 821 08  
Tel : +421 91 842 80 40

[blachere-illumination.com](http://blachere-illumination.com)